

TASCAM

TEAC Professional Division

TSR-8

1/2" 8-Track Recorder/Reproducer



OPERATION/MAINTENANCE

5700112800

The guarantee provided for the TSR-8 has several restrictions. The TSR-8 will perform properly only if it is adjusted properly and we guarantee that such adjustment is possible. Setup is not covered by Warranty. If your attempts at internal adjustments are unsuccessful, we will charge you for readjustments.

Recording is an art as well as a science. As a result, your finished product may be judged more by artistic criteria than technical performance. Art is the province of the artist and TASCAM can make no guarantee that the TSR-8, *by itself*, will assure the quality of your work.

Your skill as a technician and your abilities as an artist will be significant factors in the results you achieve.



CAUTION
RISK OF ELECTRIC SHOCK
DO NOT OPEN

CAUTION: TO REDUCE THE RISK OF ELECTRIC SHOCK, DO NOT REMOVE COVER (OR BACK). NO USER-SERVICEABLE PARTS INSIDE. REFER SERVICING TO QUALIFIED SERVICE PERSONNEL.



The lightning flash with arrowhead symbol, within an equilateral triangle, is intended to alert the user to the presence of uninsulated "dangerous voltage" within the product's enclosure that may be of sufficient magnitude to constitute a risk of electric shock to persons.



The exclamation point within an equilateral triangle is intended to alert the user to the presence of important operating and maintenance (servicing) instructions in the literature accompanying the appliance.

This appliance has a serial number located on the rear panel. Please record the model number and serial number and retain them for your records.
Model number _____
Serial number _____

WARNING: TO PREVENT FIRE OR SHOCK HAZARD, DO NOT EXPOSE THIS APPLIANCE TO RAIN OR MOISTURE.

SAFETY INSTRUCTIONS

CAUTION:

- Read all of these instructions.
- Save these instructions for later use.
- Follow all warnings and instructions marked on the audio equipment.

1. **Read Instructions** – All the safety and operating instructions should be read before the appliance is operated.
2. **Retain Instructions** – The safety and operating instructions should be retained for future reference.
3. **Heed Warnings** – All warnings on the appliance and in the operating instructions should be adhered to.
4. **Follow Instructions** – All operating and use instructions should be followed.
5. **Water and Moisture** – The appliance should not be used near water – for example, near a bathtub, washbowl, kitchen sink, laundry tub, in a wet basement, or near a swimming pool, etc.
6. **Carts and Stands** – The appliance should be used only with a cart or stand that is recommended by the manufacturer.
- 6A. An appliance and cart combination should be moved with care. Quick stops, excessive force, and uneven surfaces may cause the appliance and cart combination to overturn.



7. **Wall or Ceiling Mounting** – The appliance should be mounted to a wall or ceiling only as recommended by the manufacturer.
8. **Ventilation** – The appliance should be situated so that its location or position does not interfere with its proper ventilation. For example, the appliance should not be situated on a bed, sofa, rug, or similar surface that may block the ventilation openings; or, placed in a built-in installation, such as a bookcase or cabinet that may impede the flow of air through the ventilation openings.
9. **Heat** – The appliance should be situated away from heat sources such as radiators, heat registers, stoves, or other appliances (including amplifiers) that produce heat.
10. **Power Sources** – The appliance should be connected to a power supply only of the type described in the operating instructions or as marked on the appliance.
11. **Grounding or Polarization** – The precautions that should be taken so that the grounding or polarization means of an appliance is not defeated.
12. **Power-Cord Protection** – Power-supply cords should be routed so that they are not likely to be walked on or pinched by items placed upon or against them, paying particular attention to cords at plugs, convenience receptacles, and the point where they exit from the appliance.
13. **Cleaning** – The appliance should be cleaned only as recommended by the manufacturer.
14. **Power Lines** – An outdoor antenna should be located away from power lines.

15. **Outdoor Antenna Grounding** – If an outside antenna is connected to the receiver, be sure the antenna system is grounded so as to provide some protection against voltage surges and built up static charges. Section 810 of the National Electrical Code, ANSI/NFPA No. 70 – 1984, provides information with respect to proper grounding of the mast and supporting structure, grounding of the lead-in wire to an antenna discharge unit, size of grounding conductors, location of antenna-discharge unit, connection to grounding electrodes, and requirements for the grounding electrode. See Figure below.

EXAMPLE OF ANTENNA GROUNDING ACCORDING TO NATIONAL ELECTRICAL CODE INSTRUCTIONS CONTAINED IN ARTICLE 810 – "RADIO AND TELEVISION EQUIPMENT"

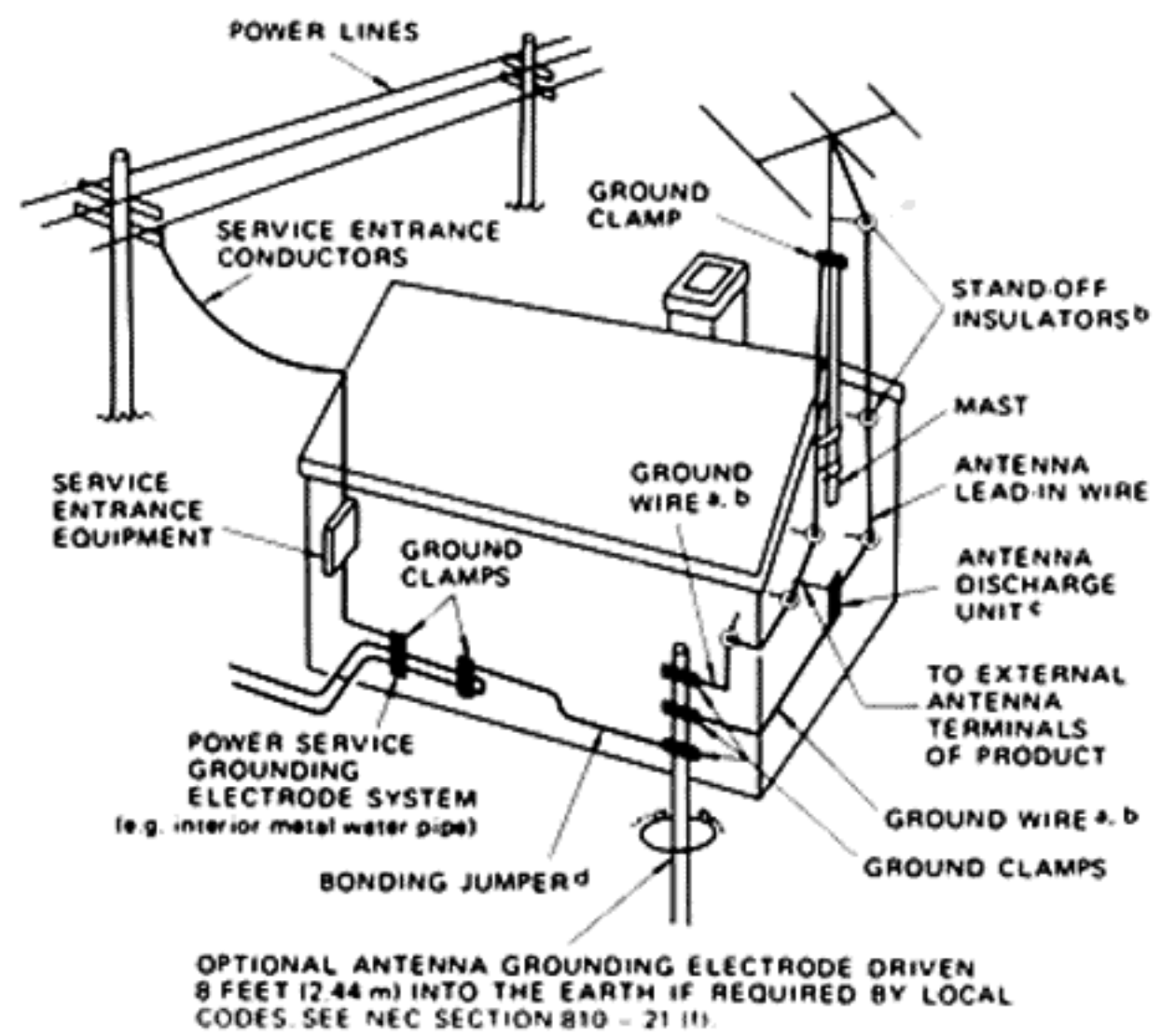

OPTIONAL ANTENNA GROUNDING ELECTRODE DRIVEN 8 FEET (2.44 m) INTO THE EARTH IF REQUIRED BY LOCAL CODES. SEE NEC SECTION 810-21 (i).

- a. Use No. 10 AWG (5.3 mm²) copper, No. 8 AWG (8.4 mm²) aluminum, No. 17 AWG (1.0 mm²) copper-clad steel or bronze wire, or larger, as a ground wire.
 - b. Secure antenna lead-in and ground wires to house with stand-off insulators spaced from 4 feet (1.22 m) to 6 feet (1.83 m) apart.
 - c. C mount antenna discharge unit as close as possible to where lead-in enters house.
 - d. Use jumper wire not smaller than No. 6 AWG (13.3 mm²) copper, or the equivalent, when a separate antenna-grounding electrode is used. See NEC Section 810-21(j).
16. **Nonuse Periods** – The power cord of the appliance should be unplugged from the outlet when left unused for a long period of time.
 17. **Object and Liquid Entry** – Care should be taken so that objects do not fall and liquids are not spilled into the enclosure through openings.
 18. **Damage Requiring Service** – The appliance should be serviced by qualified service personnel when:
 - A. The power-supply cord or the plug has been damaged; or
 - B. Objects have fallen, or liquid has been spilled into the appliance; or
 - C. The appliance has been exposed to rain; or
 - D. The appliance does not appear to operate normally or exhibits a marked change in performance; or
 - E. The appliance has been dropped, or the enclosure damaged.
 19. **Servicing** – The user should not attempt to service the appliance beyond that described in the operating instructions. All other servicing should be referred to qualified service personnel.

Introduction

The TSR-8 is an exceptionally reliable and versatile high-performance 8-track, 8-channel tape recorder/reproducer that uses 1/2-inch wide tape on 10-1/2-inch reels and operates at tape speed of 15 ips (38 cm/s).

The TSR-8 features 8-bit microcomputer control for error-free tape operation. Each channel has its own 4-bit microcomputer to control record in/out circuitry, allowing gapless punch in and out. The transport is the "full servo" type: the capstan motor is FG servoed, and each DC brushless reel motor is under control of the 8-bit microcomputer. The tension arms have non-contacting detectors that constantly send the microcomputer information on tape tension; the microcomputer then adjusts the torque of each reel motor. The result is smooth operation, gentle tape handling, and the capability in edit mode of moving both reels manually with one hand.

The TSR-8 has three different external control interfaces. It has a parallel input port, for connection to SMPTE/EBU based synchronizers (such as the TASCAM ES-50/51); and RS-232C serial synchronizers with serial control (such as the TASCAM MIDiiZER); and a remote control port for the RC-408 remote control unit. The TSR-8 automatically senses when it is under external synchronizer control, switching the servo system between the external source or its internal reference. Track 8 is fitted with a Sync Lock feature that assures high-quality time code or FSK signals (such as those generated by the TASCAM MTS-30 MIDI Tape Synchronizer) can be recorded and played back without interruption and without dbx processing.

The digital fluorescent tape counter is tach driven, displaying in minutes and seconds the distance the tape has moved from a zero reference point.

The Rehearsal and Auto In-Out features allow automated control of punch-in and out times without external computer control. When used as the first stage of the Automated punch-in/out operation, the Rehearsal feature programs the TSR-8 to repeat a punch-in/out sequence as many times as you wish before actually executing it on tape. The distance between the erase and record heads is automatically compensated, for gapless "inserts".

In addition to a conventional return-to-zero function, the TSR-8 is equipped with a two-point auto locator, which also provides a repeat playback over the desired segment of the tape.

Other features include various EDIT and spot erase features; AUTO INPUT which facilitates communication between studio and control room through the tape returns, and more.

This manual has been designed to help you as you learn how to use those features. Please read it thoroughly and keep it handy as you learn the machine. Taking the time to use this manual now will save you time later on.

TABLE OF CONTENTS

Introduction	4	7. Bouncing Tracks (Ping-pong)	20
Control Signal Block Diagram	5	8. Mixdown (Remix)	22
Specifications	6	9. Recording with Tape Sync	23
Audio Signal Block/Level Diagram	8	Features and Controls	25
Installations	9	How the dbx Works	31
Operation		Care and Maintenance	31
1. Setting the Record Level	15	Optional Equipment	32
2. Setting the Monitor Level	15		
3. Recording the First Track	15		
4. Overdubbing	16		
5. Punch-in or Insert Recording	17		
6. Rehearsal Programming and Auto-in/out Procedures	18		

(As for the contents of the Maintenance section, which provides service instructions for use by qualified personnel, see the first page of that section.)

Control Signal Block Diagram

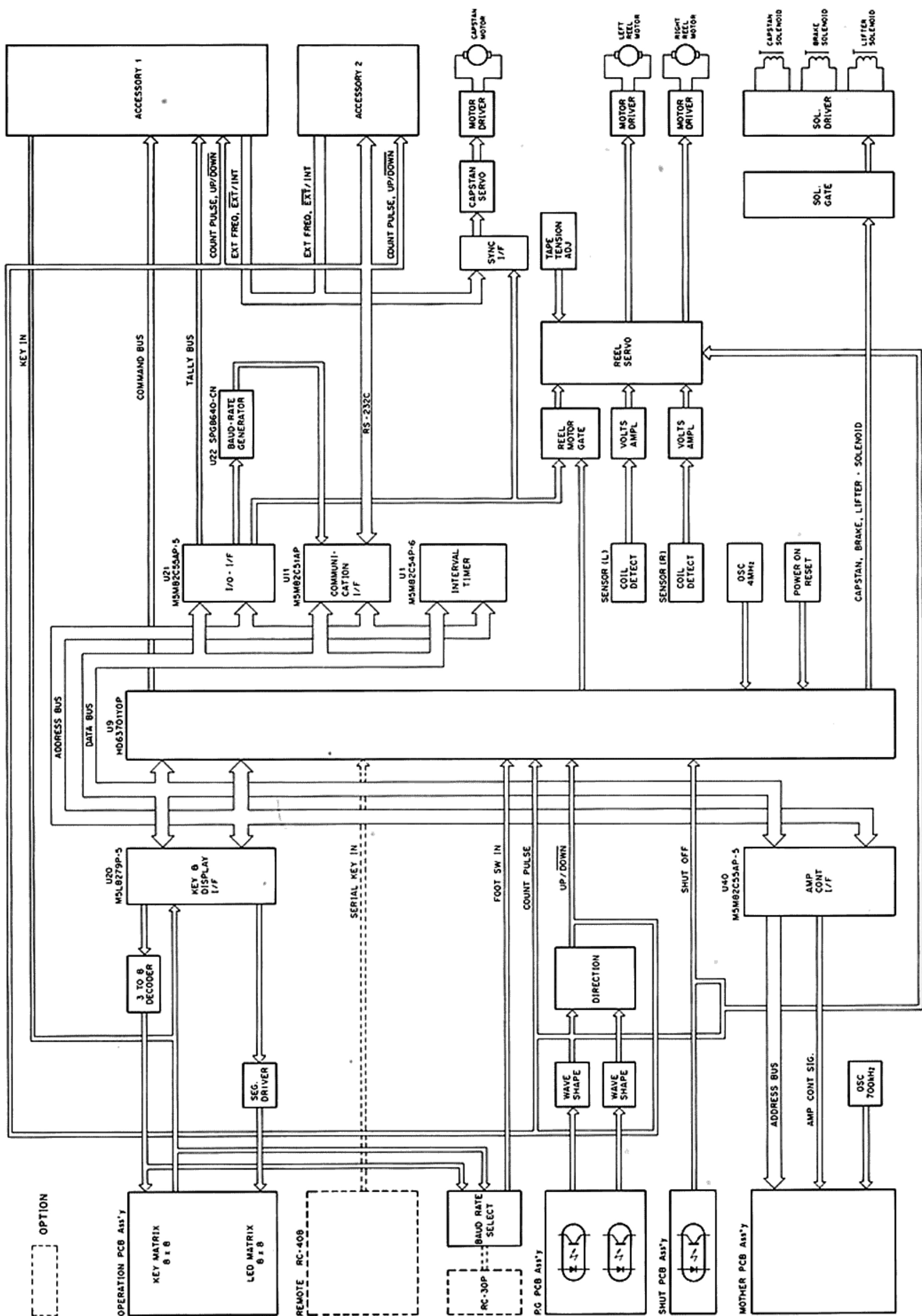

Specifications

MECHANICAL

Tape:	1/2 inch (12.7 mm), 1.5 mil, low noise/high output tape
Track Format:	8-track, 8-channel
Head Configuration:	1 erase, 1 record/reproduce
Motor:	
Capstan:	FG servo DC motor
Reel:	DC motor x 2
Reel:	10.5-inch, NAB hub
Tape Speed:	15 ips (38 cm/s)
Pitch Control Range:	±12 % (both in Record and Reproduce)
Wow and Flutter³⁾:	±0.06 % peak (DIN weighted)
Start Time:	0.8 sec. or less (to reach standard record/play speed)
Fast Wind Time:	120 sec. or less (10.5-inch reel, 2400-ft tape)
Cueing:	Electronically defeatable tape lifter
Motion sensing:	0.5 sec. ±0.15 sec. (delay time from stop to next motion)

ELECTRICAL

Line Input (Unbalanced)	
Input Impedance:	10 kOhms
Nominal Input Level:	
Ch. 1 – 7:	-10 dBV (0.316 V)
Ch. 8:	-10 dBV (0.316 V)/+4 dBu (1.23 V) in FIX, -30 dBV (0.03 V) to +4 dBu (1.23 V) in VARIABLE
Maximum Input Level:	
Ch. 1 – 7:	+18 dBV (8.0 V)
Ch. 8:	+18 dBV (8.0 V)/+24 dBu (12.3 V) in FIX, -10 dBV (0.316 V) to +24 dBu (12.3 V) in VARIABLE
Line Output (Unbalanced)	
Output Impedance:	100 Ohms
Minimum Load Impedance:	2 kOhms
Nominal Load Impedance:	10 kOhms
Nominal Output Level:	-10 dBV (0.316 V)
Maximum Output Level:	+18 dBV (8.0 V)
Bias/Erase Frequency:	145 kHz
Equalization:	∞ +35 μsec. (IEC/CCIR)
Record Level:	250 nWb/m (0 VU)
Power Requirements	
USA/CANADA:	120 V AC, 60 Hz
U.K./AUSTRALIA:	240 V AC, 50 Hz
EUROPE:	220 V AC, 50 Hz
GENERAL EXPORT:	100/120/220/240 V AC, 50/60 Hz
Power Consumption:	95 W

PERFORMANCE

Frequency Response²⁾:	40 Hz to 20 kHz ±3 dB (at 0 VU)
Repro Frequency Response¹⁾:	40 Hz to 20 kHz ±3 dB
Total Harmonic Distortion (THD)²⁾:	0.8 % or less at 1,000 Hz, 0 VU (250 nWb/m) (by the record/reproduce method)
Signal-To-Noise Ratio (ref. to 3 % THD)²⁾:	108 dB ("A" weighted, with DBX*) 68 dB ("A" weighted, without DBX)
Crosstalk (between Adjacent Channels)²⁾:	82 dB or better (1,000 Hz, 0 VU, with DBX)
Erasure:	70 dB or better (1,000 Hz, +10 VU)
Headroom (Record Amp):	25 dB or more (1,000 Hz, 0 VU)

OTHERS

Connector/Jack

- Line Input/Output: RCA jack
- Remote Control: DIN, 8-pin (for RC-408)
- Accessory 1 (Parallel): D-sub, 37-pin
- Accessory 2 (Serial): D-sub, 15-pin
- Punch-in/out Remote Control: 1/4" phone jack (for RC-30P)

Standard Equipment:

- Empty Reel (RE-1013),
- Operation/Maintenance Manual,
- Warranty Card

Option:

- RC-408 Remote Control Unit
- RC-30P Remote Footswitch
- RM-408 Rack Mount Angle
- RE-1013 Metal Reel (10.5-inch, half-inch)

Measurements were made using the following TEAC test tapes:

- 1) TEAC YTT-11442 (15 ips, 38 cm/s)
- 2) TEAC YTT-8163 Blank Tape
- 3) TEAC YTT-2104 (15 ips, 38 cm/s)

In these specifications, 0 dBV is referenced to 1.0 Volt. Actual voltage levels are also given in parentheses. To calculate the 0 dB = 0.775 Volt reference level (i.e., 0 dBm in a 600-Ohm circuit), add 2.2 dB to the listed dB value; i.e. -10 dBV re: 1 V = -7.8 dBm re: 0.775 V.

Changes in specifications and features may be made without notice and obligation.

*dbx is a registered trademark of dbx Incorporated.

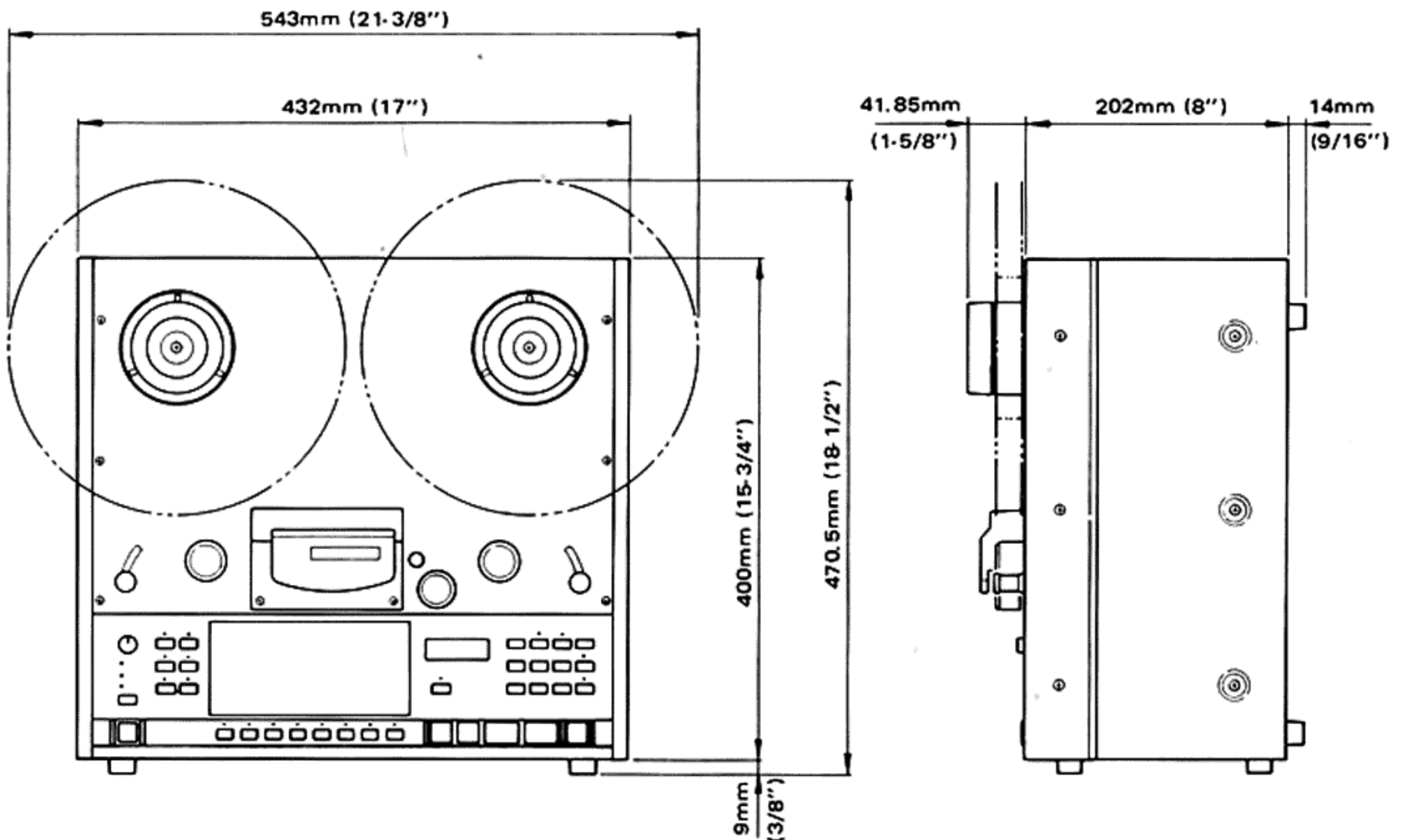

Audio Signal Block / Level Diagram

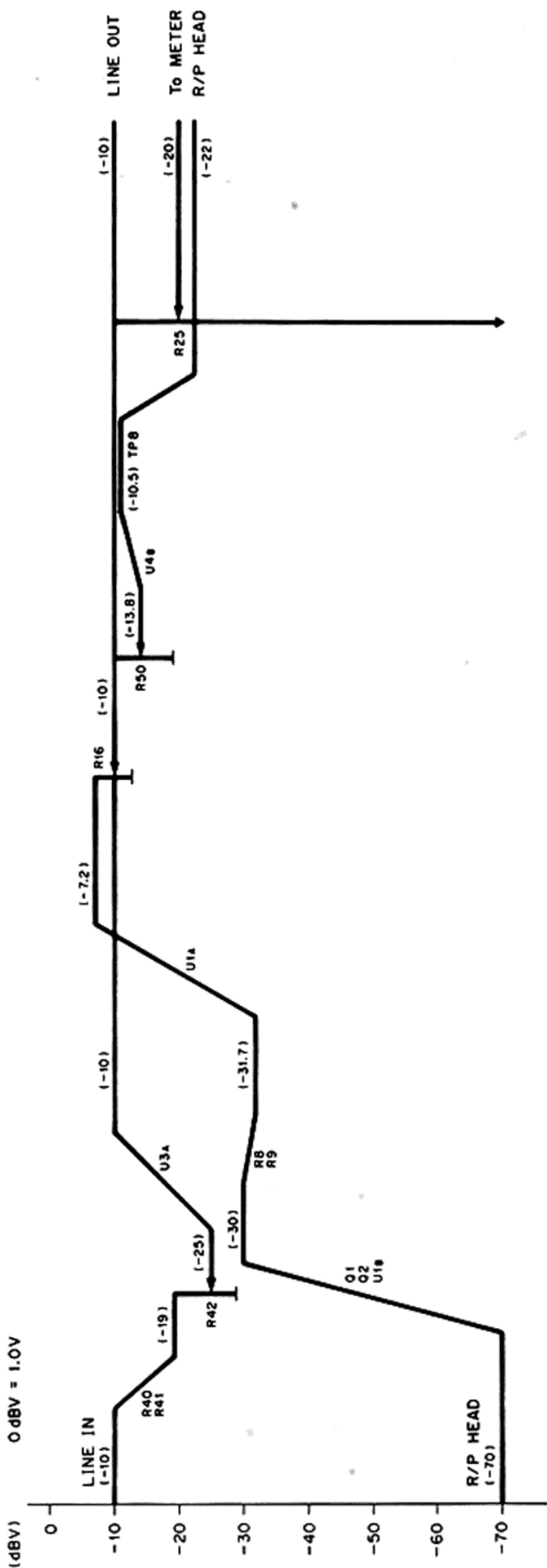
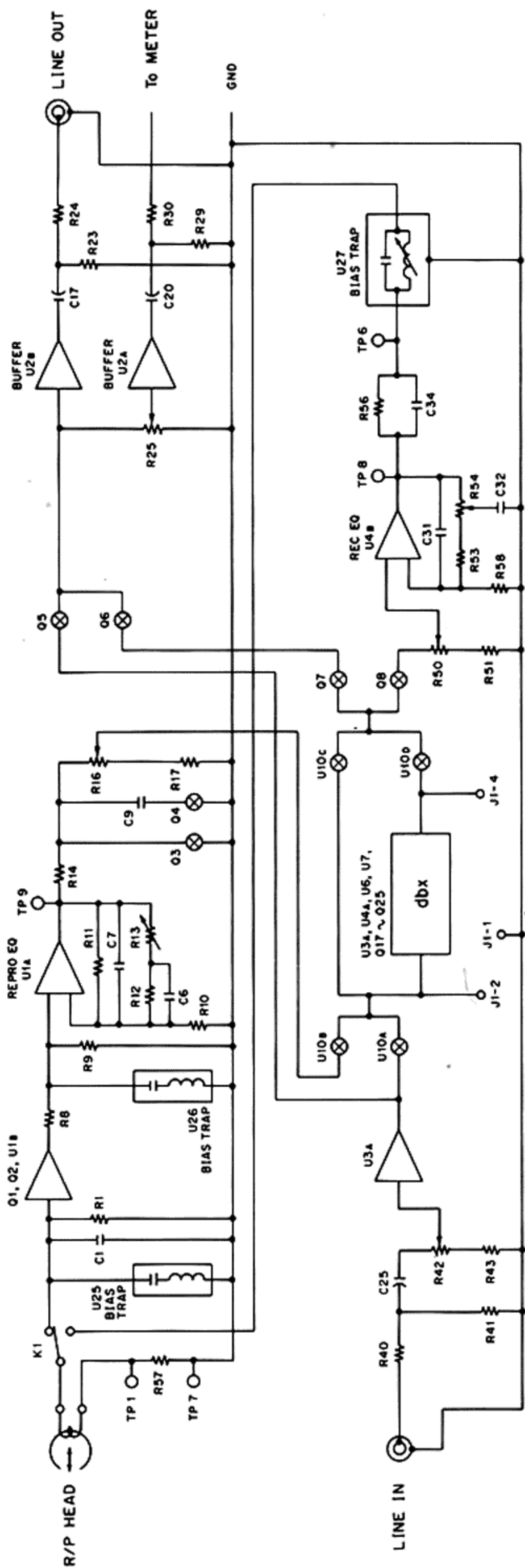

Installations

1. UNPACKING AND INSPECTION

During unpacking, be careful not to damage the TSR-8. Save the carton and packing material as well; you may need them to transport your TSR-8 sometime in the future.

After unpacking, give the machine a complete visual inspection. If there is any evidence of damage due to rough handling during transport, it is your responsibility to notify the carrier and submit a claim.

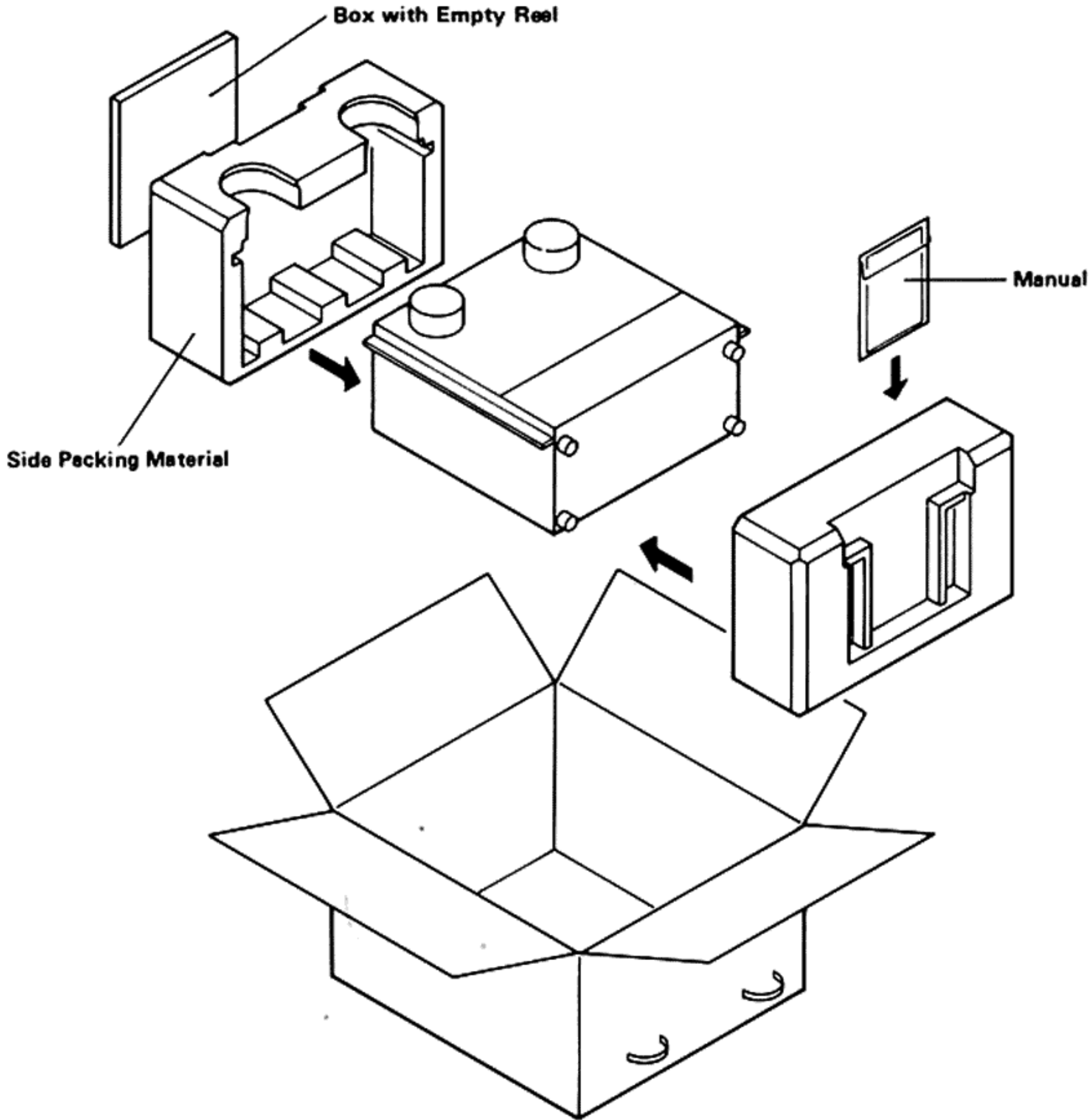

2. INSTALLATION SITE

The TSR-8 may be used in most areas, but to maintain top performance and prolong operating life, observe the following environmental limitations:

1) Nominal temperature should be 5 to 35 degrees C (41 to 95 degrees F).

2) Relative humidity should be 30 to 90% (non-condensing).

3) Strong magnetic fields should not exist nearby.

3. RACK MOUNTING THE TSR-8

The TSR-8 may be mounted to a standard EIA 19" rack, such as the TASCAM CS-607B. You need the optional RM-408 Rack Mount Angle. Before mounting, make sure the rack you are mounting the TSR-8 to is not warped or bent. Screwing the TSR-8 to badly warped surface may cause misalignment of the transport.

4. INITIAL CONNECTIONS

CAUTION: Before attempting any cable connection, check to make sure that all the units involved in your system are turned off.

When connecting the TSR-8 to your system, use shielded cables that are as short as your situation will allow. We recommend low-capacitance cables with quality connectors, such as the TASCAM Pro Series. Cheaper cable has less shielding and may introduce radio frequency interference, hum and noise into your system.

A. Input/Output Connections

The TSR-8's inputs and outputs are handled by RCA jacks located on the rear connector panel of the machine.

Make the appropriate cable connections to the Program busses and Tape Returns of your mixer.

If your mixer has phono jack (RCA) outputs conforming to the -10 dBV standard, the meter readings of your mixer and the TSR-8 should match, i.e., 0 VU on the mixer will read 0 dB on the TSR-8 track it's connected to. If the readings don't match, always go by the readings on the recorder.

B. AC Power Cord

Make sure of a stable, firm connection on the mains side. Route the cord where there is no possibility of stepping on it, to prevent accidental disconnection.

C. Remote Control Connection and Computer/Synchronizer Interface

On the TSR-8's rear panel are located a REMOTE CONTROL connector and ACCESSORY 1 and 2 connectors. The REMOTE CONTROL connection makes it possible to connect the optional RC-408 remote control unit to provide remote control of all transport functions. The ACCESSORY 1 connection is a parallel port, meaning transport controls are each brought to a separate pin of the connector for external connection to the TASCAM ES-50 or other SMPTE synchronizers. The ACCESSORY 2 is a serial port, in which fewer wires carry digital messages to and from the TSR-8's microcomputer for external connection to a controlling computer with RS-232C serial data buss. It is possible to hook up a serial-capable synchronizer (such as the TASCAM MIDiiZER) to this port for control and other advanced functions. For detailed information on the use of the ACCESSORY connections, consult TASCAM or the nearest TASCAM dealer. (Also see pp. 11-13.)

5. REEL INSTALLATION

Proceed as follows:

1. Turn the holddown knob until its outer and inner three detents line up with each other.
2. Line up the three notches in the full supply reel with the three detents in the holddown knob on the supply reel table and push the reel against the reel table.
3. Turn the holddown knob fully clockwise until it is firmly seated in place.
4. Repeat the procedure for the empty takeup reel.

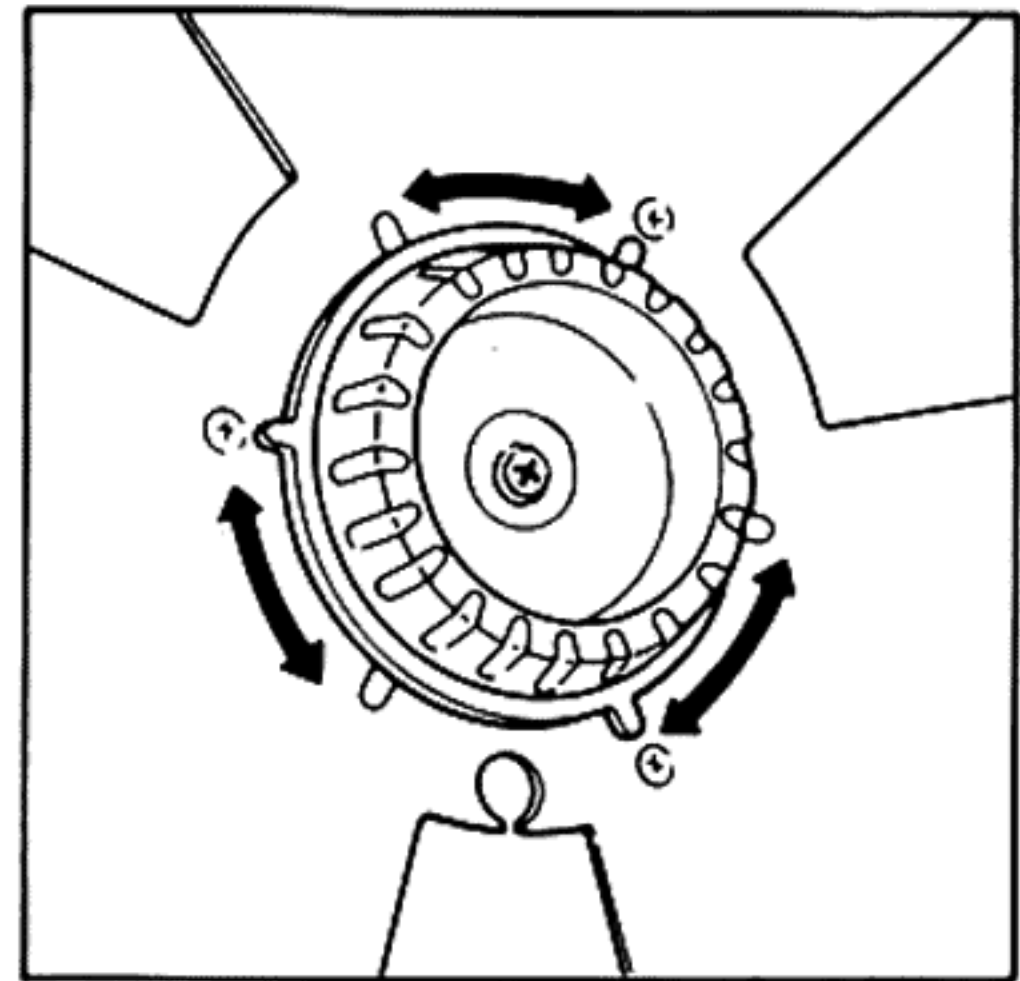

NOTE: Before running tape, make sure that the reel holddown knob is tight on both the supply and takeup reels.

6. TAPE THREADING

Thread the tape exactly as shown below.

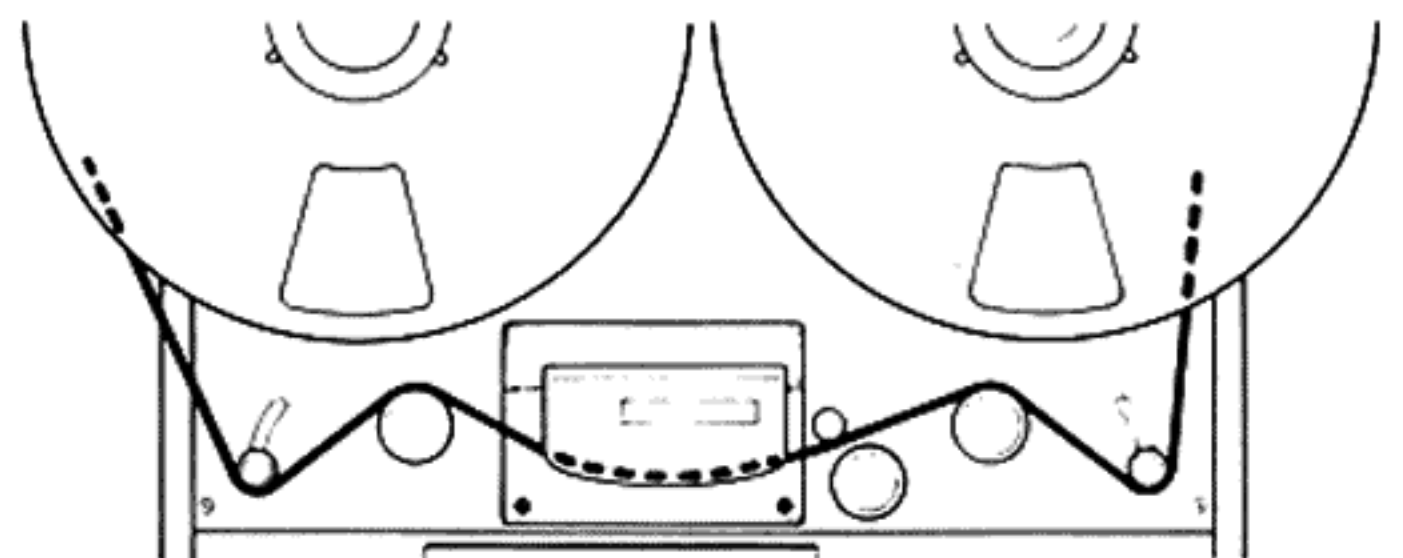

"ACCESSORY 1" PARALLEL CONNECTOR

SMPTE/EBU Time Code

SMPTE is an acronym for the Society of Motion Picture and Television Engineers. The SMPTE Time Code (C98.12: time and control code for video and audio tape for 525/30 television system) was defined in 1970, and it is now accepted as a universal standard.

This reference is to an 80-bit digital code developed by SMPTE and used to designate the exact location in hours, minutes, seconds and frames (24 frames/sec. for film or 30 frames/sec. for video) on a film, video tape, or audio tape. Suitable equipment can synchronize ("lock up") two or more machines by using the SMPTE time code recorded on each.

SMPTE European Standard, that refers to 25 frames per second, states the EBU (abbrev. for European Broadcasting Union) time code when it is especially necessary to distinguish from the USA Standard with 30 frames per second.

A *time code generator* is used to record SMPTE code onto one track of the tape. A *time code controller* can then read the code from two or more tape machines, and by also servo-controlling the reel motors of those machines, bring them to specific cue points. A *time code synchronizer* further controls the capstan motors to keep both of the tape machines running synchronously. These techniques can be used to obtain more tracks for recording (two or more audio machines "locked up" together), to mix audio signals in sync with video or film images, to make complex edits by transferring material from one or more audio machines to another, and so forth.

Connecting a Synchronizer to the TASCAM TSR-8

Connection between the ES-50 synchronizer/ES-51 edit controller and the TSR-8 is a plug-and-go proposition. Pre-wired interface cables needed are available from TASCAM.

The TASCAM TSR-8 provides signals to the synchronizer (via the ACCESSORY "1" connector) which indicate its speed, the direction of the tape travel, and a reference power supply. Also, tally signals indicating the TSR-8's mode (PLAY, F.FWD, REW, STOP) are given to the synchronizer so it knows the current transport status. Inputs on the same ACCESSORY "1" connector are provided for status commands from the synchronizer (PLAY, F.FWD, REW, STOP, REC, LIFTER CONT). Also, there is an input for a capstan drive reference frequency signal from the synchronizer so that the actual record/play speed can be varied to maintain synchronization. For pin assignment see page 12.

The TSR-8 will also operate satisfactorily with a variety of other manufacturers' synchronizer/controllers. The manual for these products should provide you with enough interface information for use with the TASCAM tape machines. Or else, consult the synchronizer manufacturer for further details on interfacing.

"ACCESSORY 2" SERIAL CONNECTOR

The TSR-8 operates to its full potential when interfaced with the MIDiiZER, an intelligent, highly versatile serial synchronizer, which provides a link between SMPTE/EBU based audio/video production and MIDI music creation. It shifts between time code and MIDI data to constantly adapt the TSR-8 and other associated machines/units to ever changing requirements of each application.

Specifically, advanced functions the MIDiiZER provides access to, include Record On/Off Programming (up to 16 individual tracks), 20-point Autolocation, Synchronization either referenced to time code addresses or MIDI coded bar numbers, Time code/MIDI data triggered events, MIDI Program Change which can be controlled with time code too, a "Total Time" function which accommodates your program material to the required length by automatically changing the tempo, and more. (Complete, update information about the MIDiiZER will be made available no later than its upcoming release.)

The method of communications performed in compliance with the RS-232C standard differ depending on the mechanical/electrical characteristics and system programs of the associated machines/devices, and a small error in communications thwarts the interfaced system and even causes this to run "wild." For detailed technical information about the use of the TSR-8's Serial Port consult TASCAM or your local TASCAM dealer.

ACCESSORY 1 Pin Assignment

Pin =	IN(put)-OUT(put) signals	Function
1	$\overline{\text{PLAY}}$ IN	Inputs PLAY signal at L level.
2	$\overline{\text{FF}}$ IN	Inputs FF signal at L level.
3	$\overline{\text{REW}}$ IN	Inputs REW signal at L level.
4	open terminal	
5	$\overline{\text{STOP}}$ IN	Inputs STOP signal at L level.
6	$\overline{\text{REC}}$ IN	Inputs REC signal at L level.
7	$\overline{\text{LIFTER CONT}}$ IN	Inputs LIFTER shift cancellation signal at L level.
8	open terminal	
9	$\overline{\text{UP/DOWN}}$ OUT	Outputs tape running control signal at H or L level.
10	CP OUT	Outputs open-collector signal (12 Hz pulse at 15 ips.)
11	$\overline{\text{PLAY TALLY}}$ OUT	Outputs open-collector signal (Low level during PLAY mode.)
12	$\overline{\text{FF TALLY}}$ OUT	Outputs open-collector signal (Low level during FF mode.)
13	$\overline{\text{REW TALLY}}$ OUT	Outputs open-collector signal (Low level during REW mode.)
14	$\overline{\text{STOP TALLY}}$ OUT	Outputs open-collector signal (Low level during STOP mode.)
15	$\overline{\text{REC TALLY}}$ OUT	Outputs open-collector signal (Low level during record mode)
16	$\overline{\text{SHUT-OFF TALLY}}$ OUT	Outputs open-collector signal (Low level during tape stop)
17	open terminal	
18	open terminal	
19	$\overline{\text{REW COMMAND}}$ OUT	Outputs open-collector signal (Low level when REW is pressed)
20	$\overline{\text{FF COMMAND}}$ OUT	Outputs open-collector signal (Low level when F. FWD is pressed)

Pin =	IN(put)-OUT(put) signals	Function
21	$\overline{\text{PLAY COMMAND}}$ OUT	Outputs open-collector signal (Low level when PLAY is pressed)
22	$\overline{\text{STOP COMMAND}}$ OUT	Outputs open-collector signal (Low level when STOP is pressed)
23	$\overline{\text{REC COMMAND}}$ OUT	Outputs open-collector signal (Low level when REC is pressed)
24	$\overline{\text{RHEARSAL MODE}}$ IN	Accepts Rehearsal enabling signal coming from a properly equipped external control unit (low level with Rehearsal In)
25		
26		
27		
28		
29		
30		
31	EXT FREQ IN (HOT)	Inputs speed control signal at input signal of 3.0 V or more and of 4.8 k to 19.2 kHz (HOT side)
32	EXT FREQ IN (COLD)	Inputs speed control signal (COLD side)
33	INT/EXT IN	Inputs internal/external speed control select signal Internal: HIGH level External: LOW level
34	open terminal	
35	+15 V supply voltage OUT	Maximum: 50 mA
36	Main unit GND	
37	+5 V supply voltage OUT	Maximum: 50 mA

ACCESSORY 1 Connector Pins and External Signal Connections

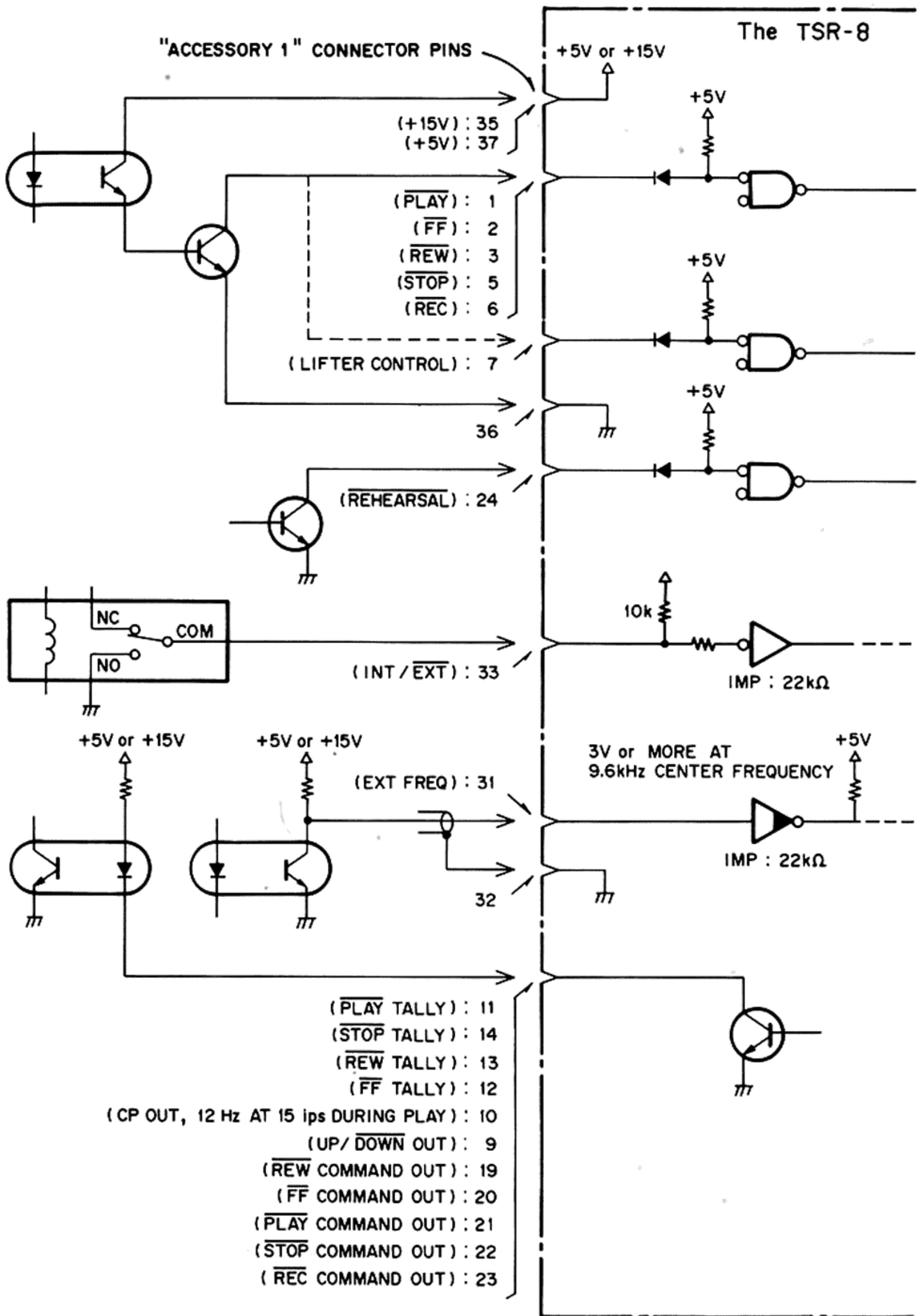

VOLTAGE CONVERSION

NOTE: Voltage conversion is not possible on models sold in the U.S.A., Canada, U.K., Australia or Europe.

For general export models, if the input voltage specified on the TSR-8 or packing carton differs from the line voltage at the installation site, please request your dealer to change the voltage setting of the machine. The procedure entails the opening of the machine.

NOTE FOR U.K. CUSTOMERS

U.K. Customers Only:

Due to the variety of plugs being used in the U.K., this unit is sold without an AC plug. Please request your dealer to install the correct plug to match the mains power outlet where your unit will be used as per these instructions.

IMPORTANT

The wires in this mains lead are coloured in accordance with the following code:

BLUE:	NEUTRAL
BROWN:	LIVE

As the colours of the wires in the mains lead of this apparatus may not correspond with the colours markings identifying the terminals of your plug, proceed as follows.

The wire which is coloured BLUE must be connected to the terminal which is marked with the letter N or coloured BLACK. The wire which is coloured BROWN must be connected to the terminal which is marked with the letter L or coloured RED.

Bescheinigung des Herstellers/Importeurs

Hiermit wird bescheinigt, daß der/die/das

MAGNETTONBANDGERÄT TASCAM TSR-8

(Gerät, Typ, Bezeichnung)

in Übereinstimmung mit den Bestimmungen der

AMTSBLATT 163/1984, VFG 1045/1984, VFG 1046/1984

(Amtsblattverfügung)

funk-entstört ist.

Der Deutschen Bundespost wurde das Inverkehrbringen dieses Gerätes angezeigt und die Berechtigung zur Überprüfung der Serie auf Einhaltung der Bestimmungen eingeräumt.

TEAC CORPORATION

Name des Herstellers/Importeurs

This product is manufactured to comply with the radio interference of EEC directive "82/499/EEC."

THIS DIGITAL APPARATUS DOES NOT EXCEED THE CLASS B LIMITS FOR RADIO NOISE EMISSIONS FROM DIGITAL APPARATUS AS SET OUT IN THE RADIO INTERFERENCE REGULATIONS OF THE CANADIAN DEPARTMENT OF COMMUNICATIONS.

LE PRESENT APPAREIL NUMERIQUE N'EMET PAS DE BRUITS RADIOELECTRIQUES DEPASSANT LES LIMITES APPLICABLES AUX APPAREILS NUMERIQUES DE CLASSE B PRESCRITES DANS LE REGLEMENT SUR LE BROUILLAGE RADIOELECTRIQUE EDICTE PAR LE MINISTERE DES COMMUNICATIONS DU CANADA.



Operation

1. SETTING THE RECORD LEVEL

The TSR-8 does not utilize its own controls for setting the volume or "level" of the signal to be recorded. Therefore the recording level is adjusted on the mixer. The basic procedure for setting the record level is as follows:

1. Consult your mixer manual for information about setting its Input Trims, Faders, EQ's and other controls that have an effect on the output level of the mixer. Set these controls to their nominal levels on the mixer.

2. Switch power on to the TSR-8. The digital counter will indicate "-88.8.8" for a few seconds as the machine's logic circuits initialize, then the display will change to "00.00."

In the following illustrations,  shows a blinking LED, and  a steadily lit LED.

(Recording the First Track)

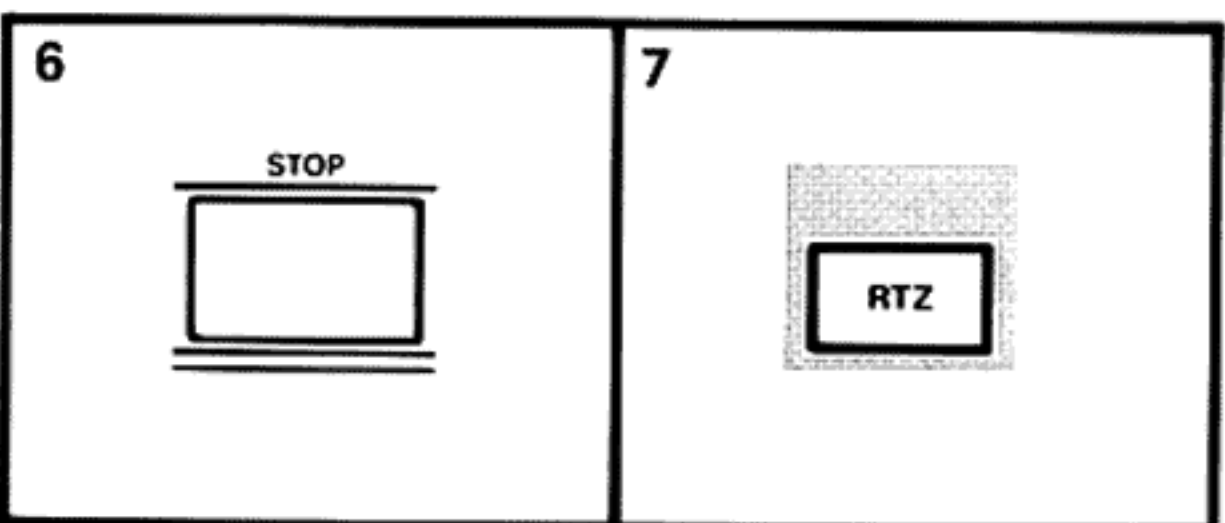
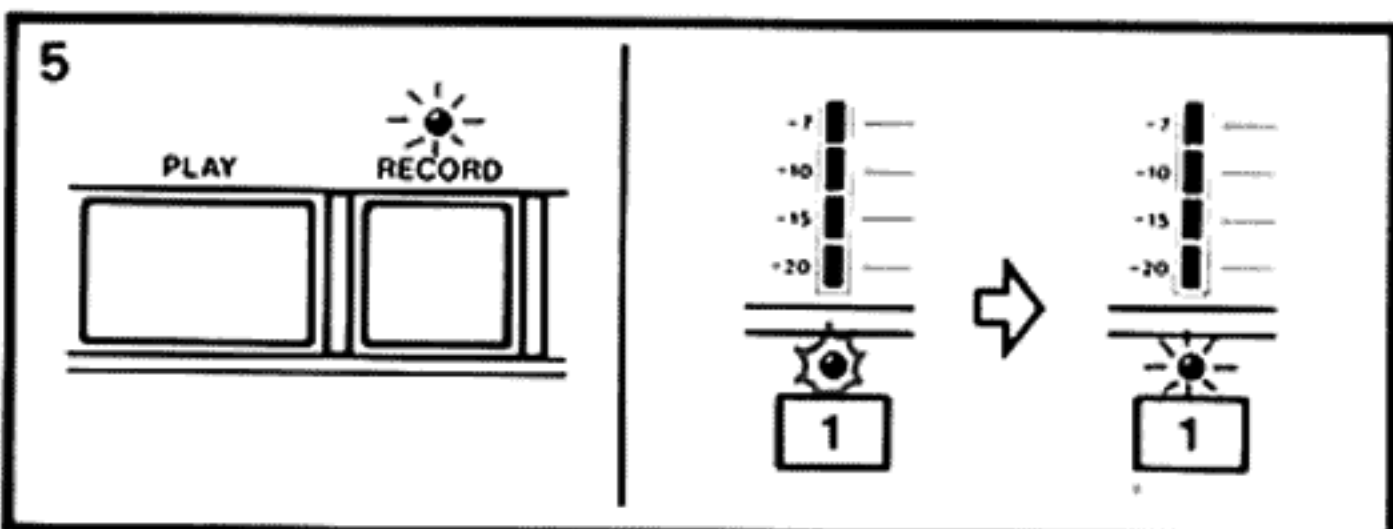
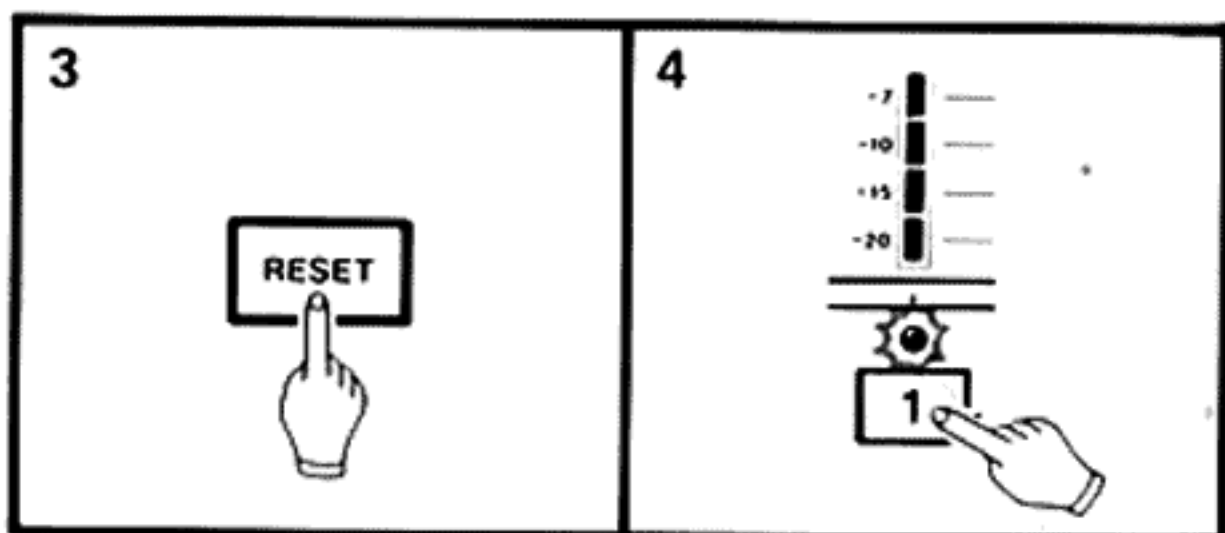
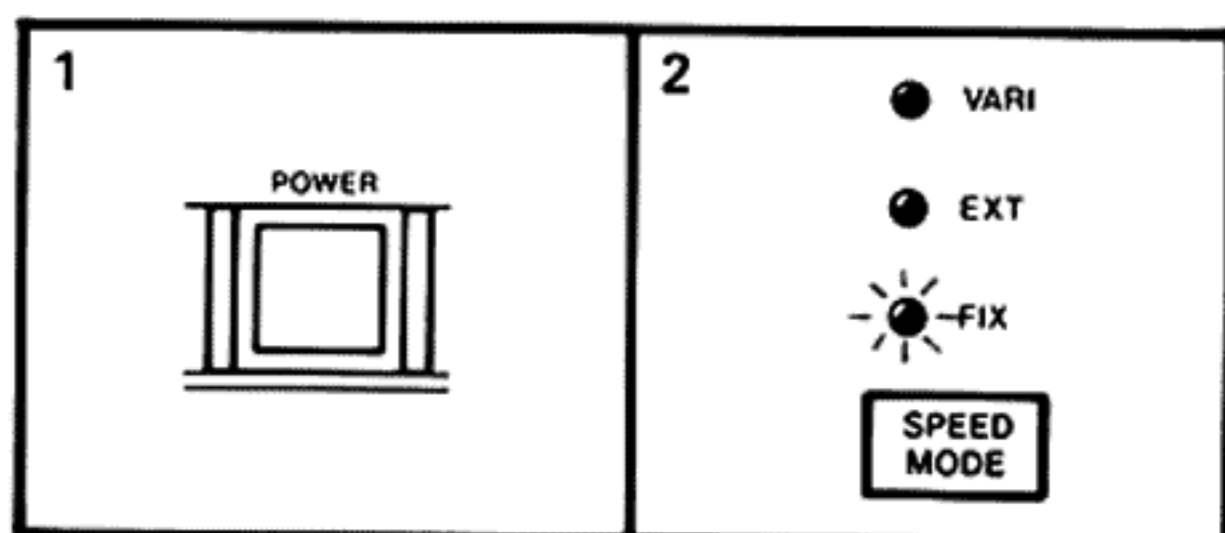

3. Press the Record Enable button for a track being fed by the mixer output.

4. Play an instrument (or speak into a mic). While you are doing this, watch the meter on the mixer and the track's LED meter on the TSR-8. At the loudest point, both meters should peak at the reference level of "0." If not, adjust the level of the source.

2. SETTING THE MONITOR LEVEL

The monitoring of both the recorded material as well as the source during the recording process is accomplished through the mixer's monitor section. Refer to the mixer's manual for the correct procedure in setting up the monitoring system.

3. RECORDING THE FIRST TRACK

When all necessary level adjustments on your mixer are complete, you can go ahead with your recording. As an example, we will assume that you wish to use Track #1 as a rhythm track.

1. If the TSR-8 is not on, press the POWER switch.

2. Check to see that the SPEED MODE selector switch is set to its FIX position and its green LED is on solid. If not, set it to FIX.

3. Press RESET so you'll know where you started from.

4. Press the Record Enable button for track #1 (track we use only as an example). A red LED will begin flashing on and off above the track's Record Enable button.

5. Press and hold down the Master RECORD button. While still holding RECORD down, press the PLAY button. The tape will begin moving in its forward direction and recording is now in progress on Track #1. The RECORD LED should light solid and the LED above the track's Record Enable button that was flashing should also now be on solid.

6. When you have finished with recording, press STOP to terminate the recording. The RECORD LED will turn off and the track's LED will begin flashing as before.

7. Press the "RTZ" (Return to Zero) button. The tape will rewind, automatically stopping at counter zero point.

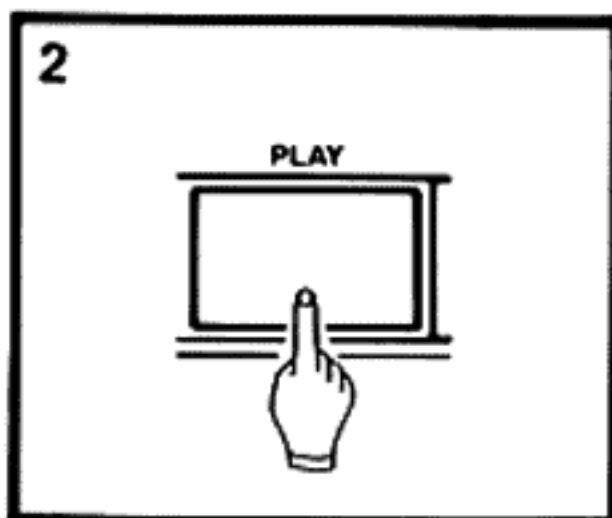
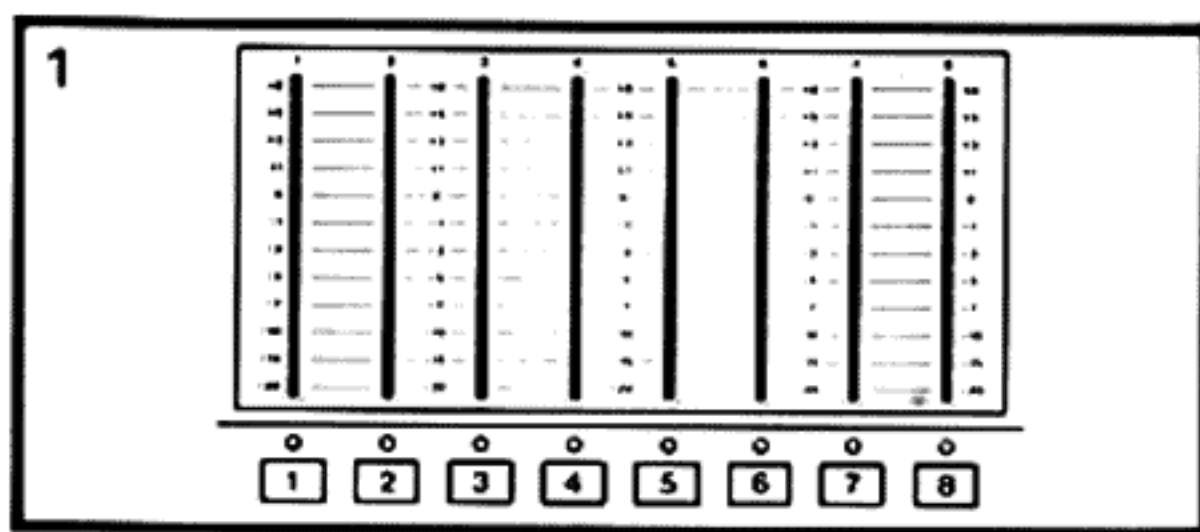

First Playback

1. Release the Track 1 Record button by pressing it. Its blinking LED will go out showing that Track #1 is now in "safety" status. Check to make sure that all other tracks are also in "safety" status with their LEDs off.

2. Press PLAY. The track you just recorded can be listened (monitored) through the mixer.

If you are not satisfied with your first take and want to re-record it (thereby erasing the first take), all you have to do is:

- Make any changes that occurred to you while you listened to the first playback.
- Press RTZ to rewind the tape to 00.00.
- Press the Track 1 Record Enable button.
- Press RECORD and PLAY together and try again.

Once you have a basic track you're satisfied with, you are ready to move on to overdubbing.

4. OVERDUBBING

There are two tasks in overdubbing. First, the new signals must be adjusted for proper level going to the TSR-8, as in tracking. Second, you must make a proper monitoring mix of the existing track(s). Here is a basic overdubbing procedure:

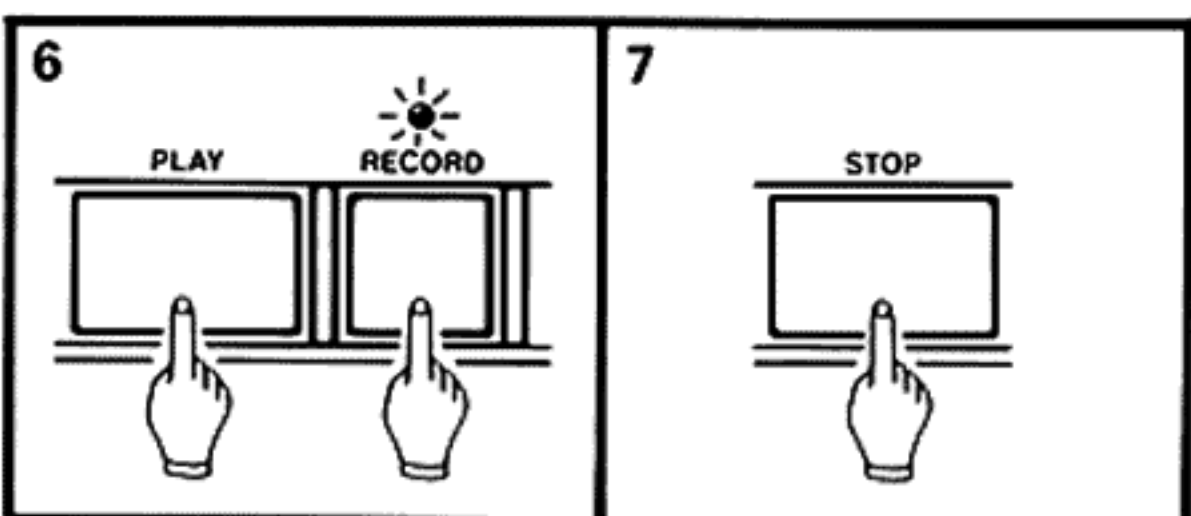
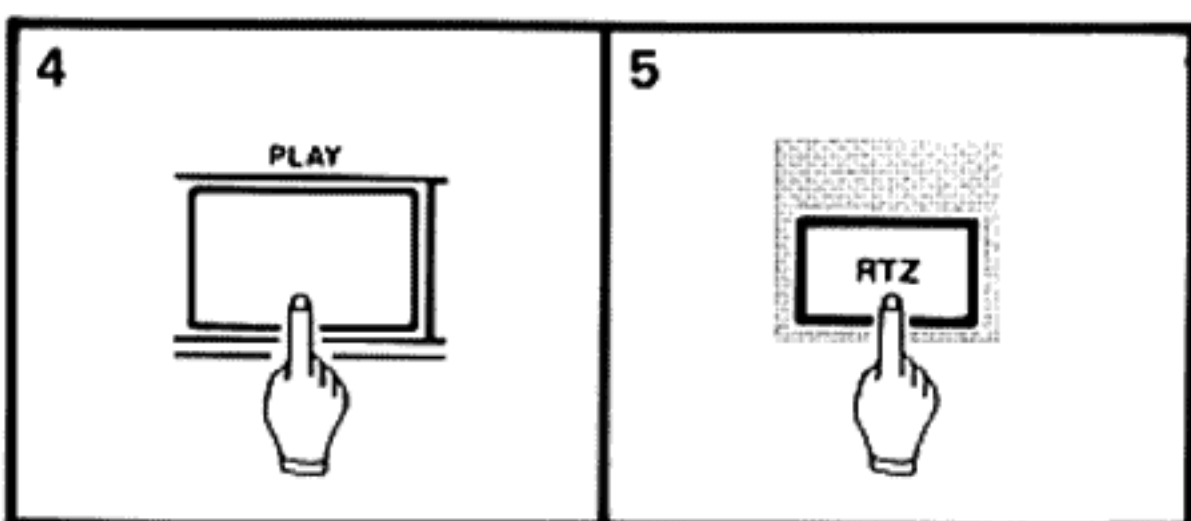
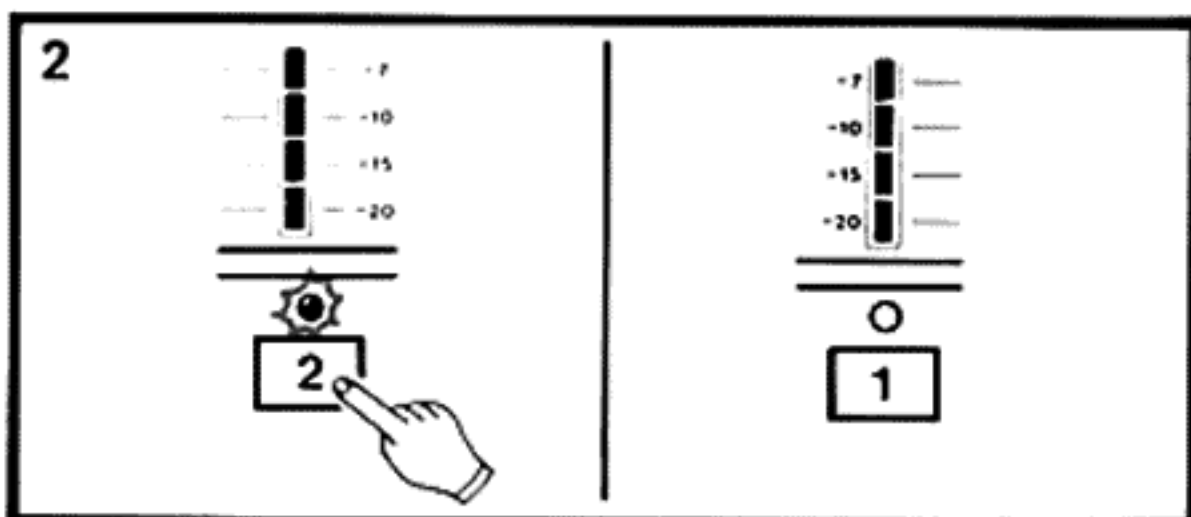

1. Select an open track for the overdub: Since we assume, in our example, that you have recorded your first take on track 1, you can choose any other track for the overdub. Factors affecting which track you choose include how many total parts you will record, and whether you plan to bounce ("ping-pong") tracks later. In this example, we'll assume that you choose track 2.

2. Place the track in record ready mode: Press the Record Enable button for track 2. Its LED will start blinking. Make sure that previously recorded tracks (such as track 1 in our example) are in safe mode so you don't accidentally erase them.

3. Adjust the recording level of the new sources using your mixer controls, watching the meter level on track 2.

4. Play the tape and adjust monitor levels for a proper balance of the incoming new signal with the signal being played back from track 1 in your headphones or monitor.

5. Rehearse your overdub until you feel confident that your levels are correct. Rewind to 00.00 by pressing RTZ.

6. Record the first overdub by pressing RECORD and PLAY.

7. Stop the recording by pressing STOP (or PLAY).

8. To listen to playback of the overdub, press the track 2's record enable button (to place the track in safe mode), then rewind to the beginning of the take and hit PLAY.

5. PUNCH-IN OR INSERT RECORDING

The TSR-8 can manually punch in with the master RECORD button, the Track Record Enable buttons, or the optional RC-30P footswitch. You can also program the punch-in and punch-out with the REHEARSAL and AUTO IN/OUT functions so the TSR-8 automatically punches in and out for you.

Manual Punch-In

METHOD A: Punching with the master RECORD button or footswitch

1. Make the following preliminary settings:
 - a) Press the Record Enable button of the track you intend to INSERT on. Its LED will start blinking.
 - b) Press the INSERT switch. Its LED will light solid.
 - c) Adjust the recording and monitoring levels for the desired balance.

2. Press PLAY. You can use the INSERT switch to toggle the TSR-8's meter and output between source and tape. While the tape is in PLAY and INSERT is on, you'll hear tape; while tape is stopped or INSERT is off, you'll hear source.

3. When the tape reaches the desired punch-in point, press RECORD or the footswitch to start recording. The monitor switches from tape to input on that track. The master RECORD LED and Track Record LED both stay on.

4. Punch out by pressing STOP, PLAY or the footswitch.

METHOD B: Punching with the Track Record button

This method is sometimes called "rolling in record" and requires that you have a free hand.

1. After the recording and monitoring levels are set, make sure that all tracks are SAFE (no track LED blinking).

2. Press RECORD and PLAY together to start playing the tape. The RECORD LED will blink, showing that the TSR-8 is in record-ready mode.

3. Press the punch-in track's record button when the tape reaches the punch-in point. The master RECORD and track record LEDs will both light up steadily, showing that recording is taking place.

4. To punch out, press the Track Record button again (you could also press STOP or PLAY).

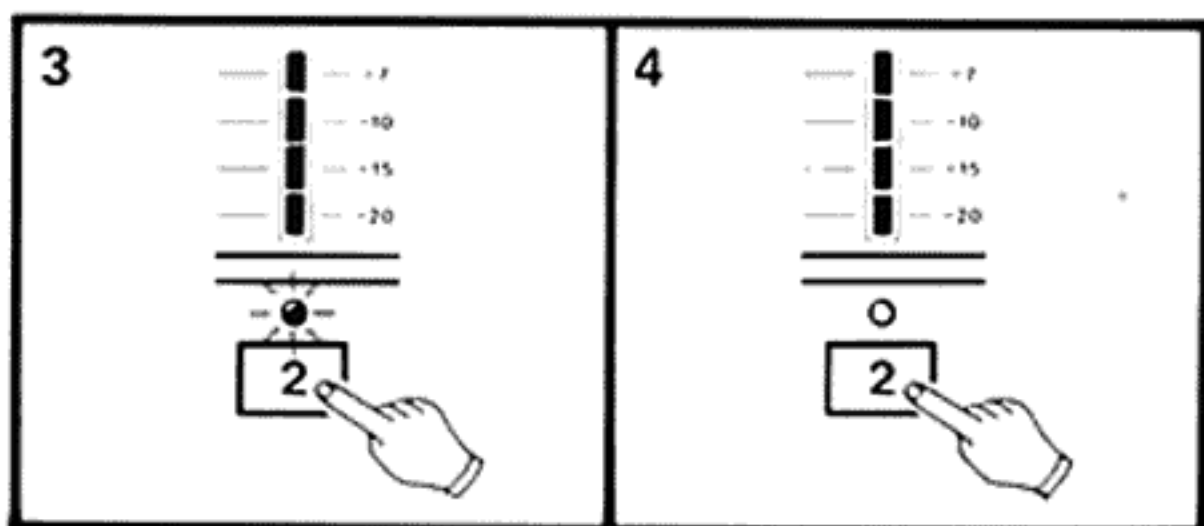
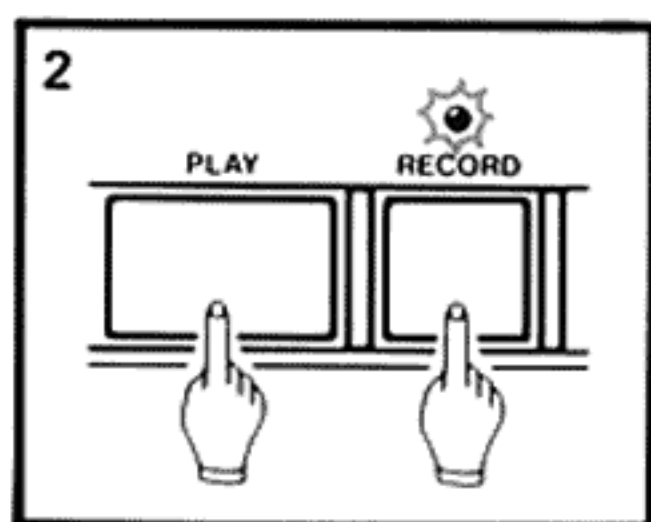
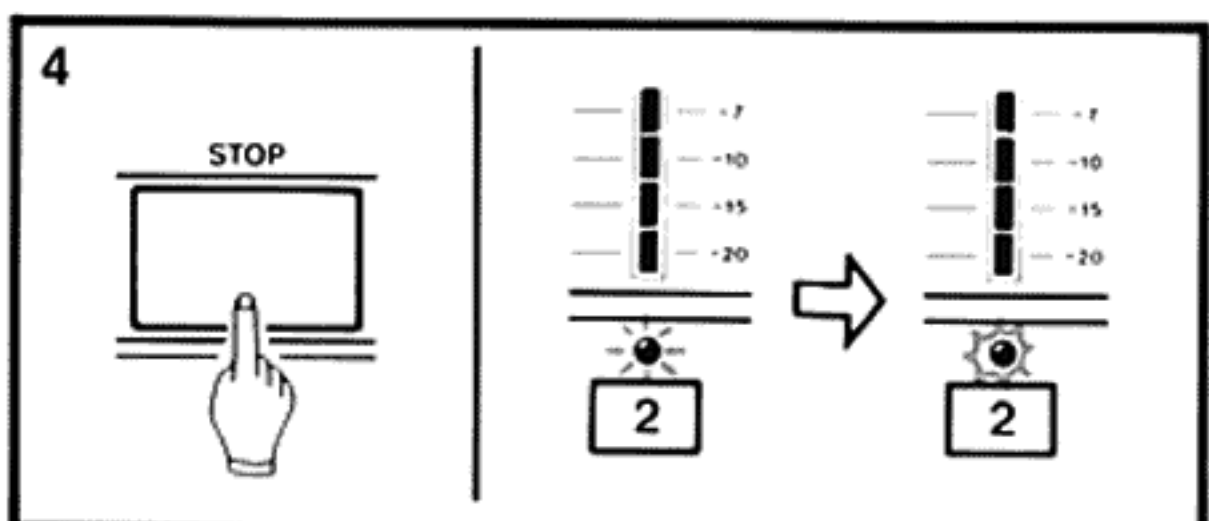
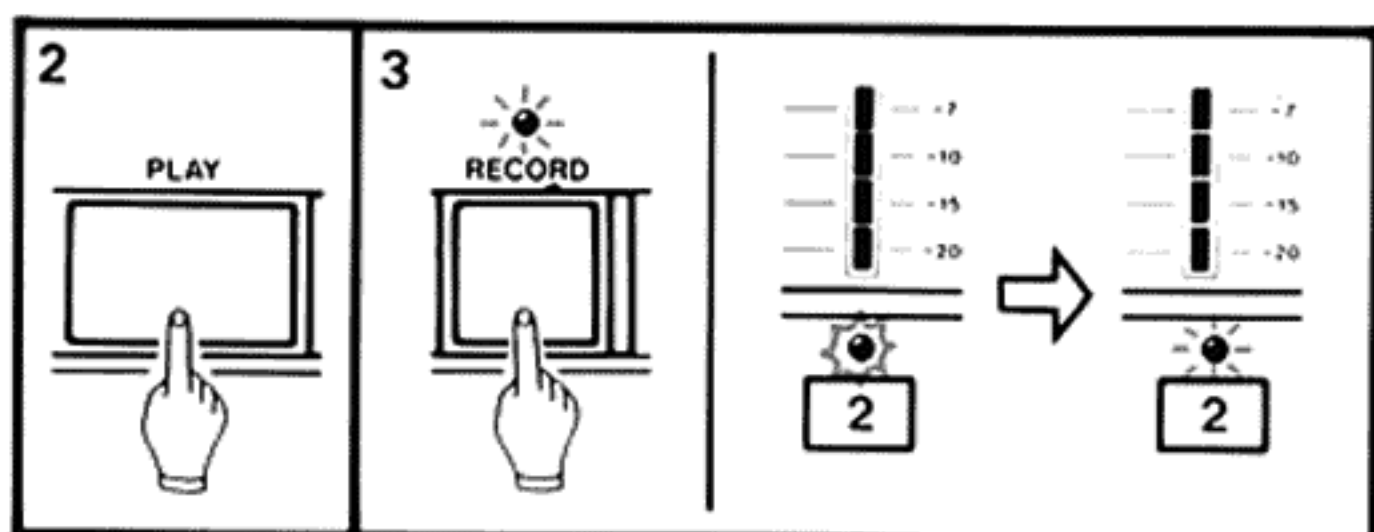
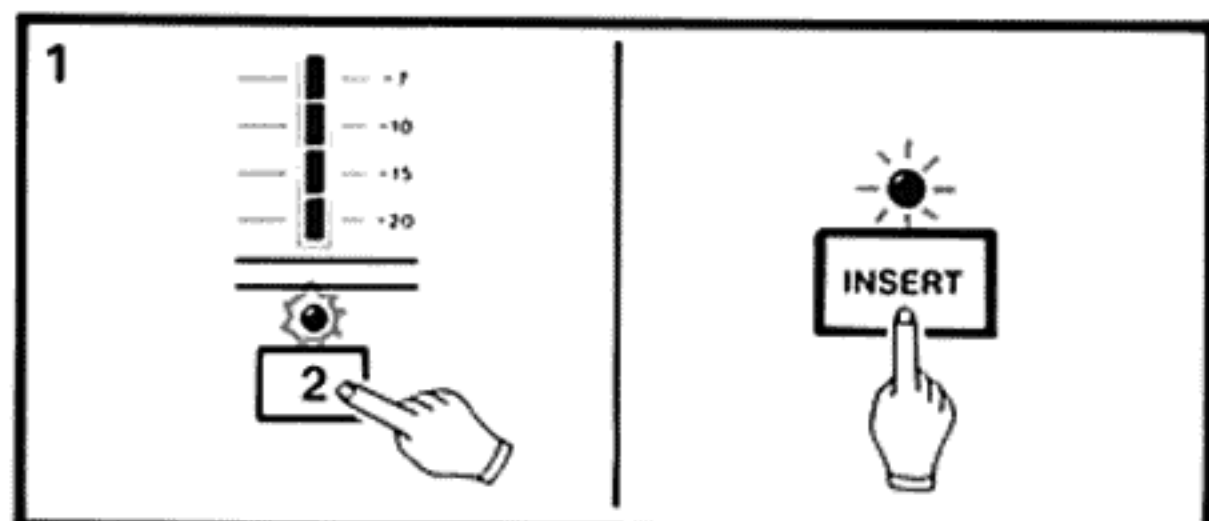

6. REHEARSAL PROGRAMMING AND AUTO IN/OUT PROCEDURES

The Auto Locator has priority over the Rehearsal and Auto In/Out modes. If LOC 1, LOC 2, REPEAT, or RTZ is pressed, the function pressed is activated erasing all the memories you have set for punch-in. The LED RHSL or AUTO IN/OUT will then blink until CLEAR is pressed.

Programmed Rehearsal of Inserts (RHSL)

Before you actually record an insert, the TSR-8 allows you to "preview" the punch-in and out points with its special REHEARSE function. During a rehearsal, the tracks in record ready mode will switch

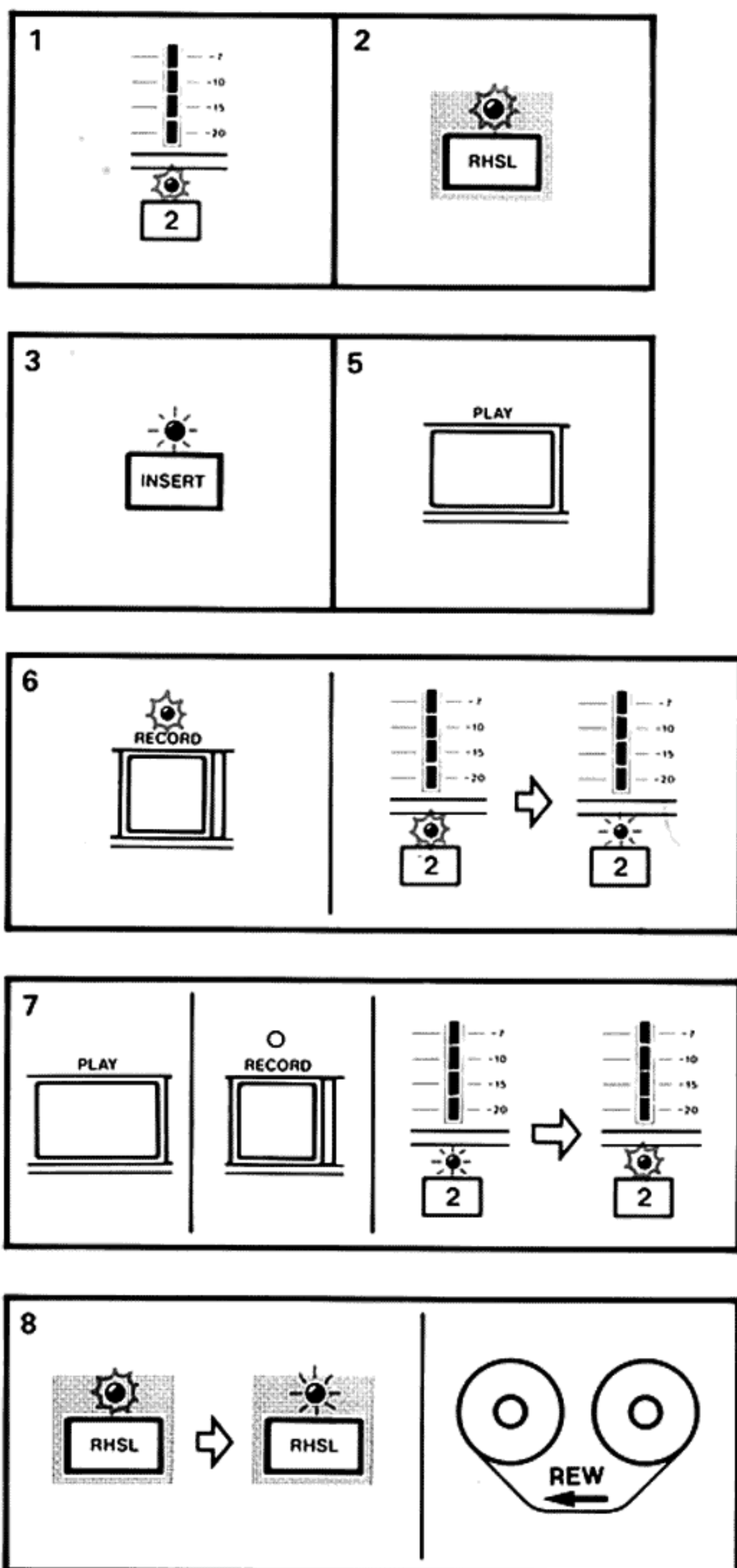

meter and output from tape to source and back again, but won't actually record. What you hear in your monitor mix will be the same as during recording; so if the first in-out points aren't correct, you'll hear it and can CLEAR the old points and try again until you've got exactly what you want.

CAUTION: Although the advanced circuitry of the TSR-8 allows gapless punch-in on the tape, there is still the distance between the erase and record heads to be compensated for. Depending on tape speed, the time from a punch point to the actual in/out is 1/15th or 1/8th of a second. A few practice runs will get you accustomed to the timing of punching in.

Entering the Automatic Preroll and Punch-In/Out Points

NOTE: If you want to quit what you are doing at any time during the following procedures, press CLEAR.

1. Press the Record Enable button of the track you want to punch-in on. Its LED will start blinking. Check to make sure that all other tracks are in safe mode.

2. Press the RHSL switch. Its LED will begin blinking. As long as this light blinks (or stays on solid as it will do later, in step 8), you can't actually record, even though the master RECORD and track's Record LEDs may go on solid.

3. Press the INSERT switch. Its LED will light.

4. Adjust the record and monitoring levels on the mixer for the desired balance.

5. Press PLAY. That point on the tape will be put into memory defined as the preroll start point.

6. At the punch-in point, press RECORD or the footswitch. Your punch-in point will be put into memory. The track's record LED will light steadily, but the master RECORD LED will blink, showing that recording is not actually taking place.

7. Press PLAY or the footswitch when the tape reaches the punch-out point. That point will be put into memory. The LED for the selected track will start blinking and the RECORD LED will turn off.

8. After a 3-second postroll, the RHSL LED will go on solid, while the tape will automatically rewind, stopping at the preset start point. The TSR-8 is now in Rehearsal Ready mode.

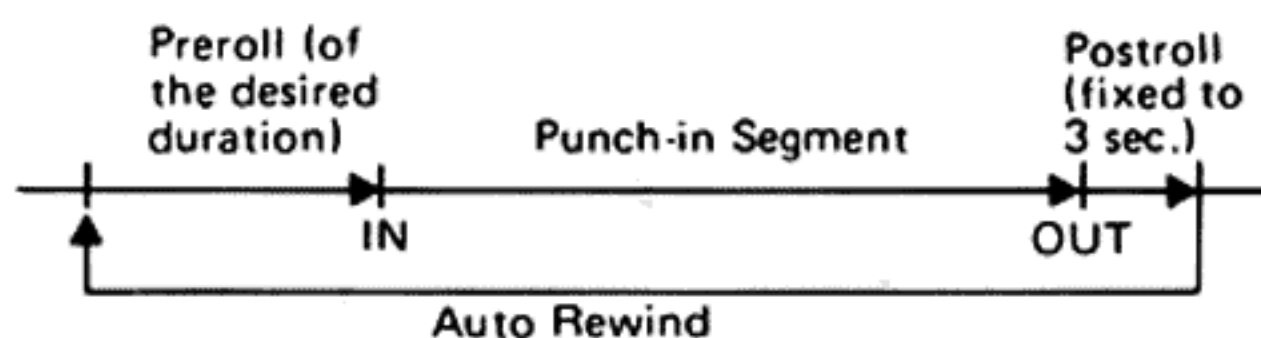

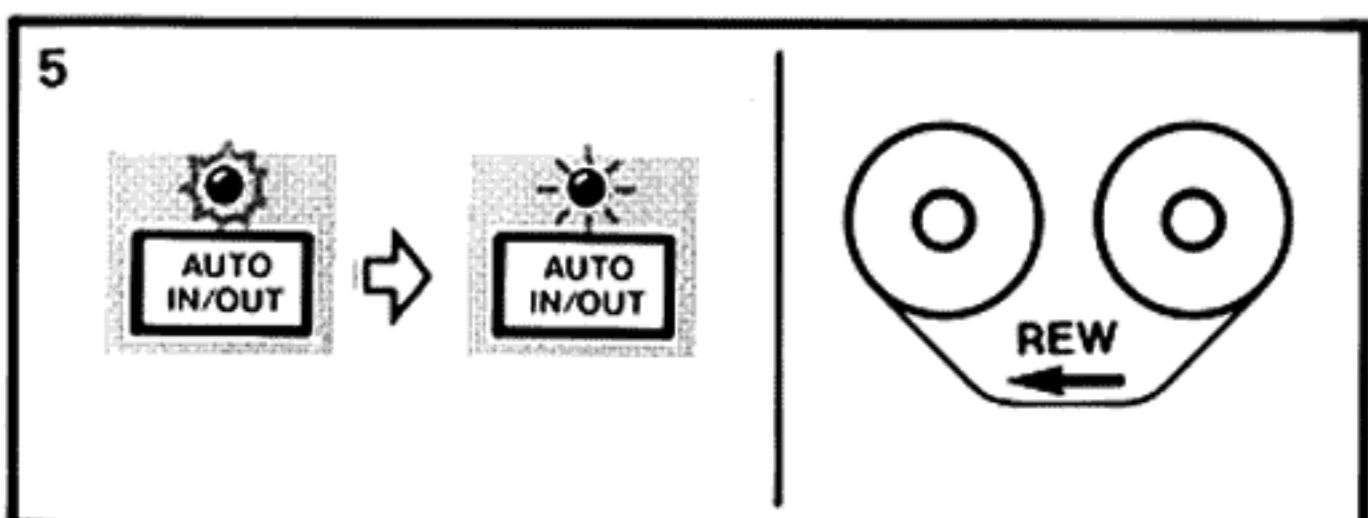
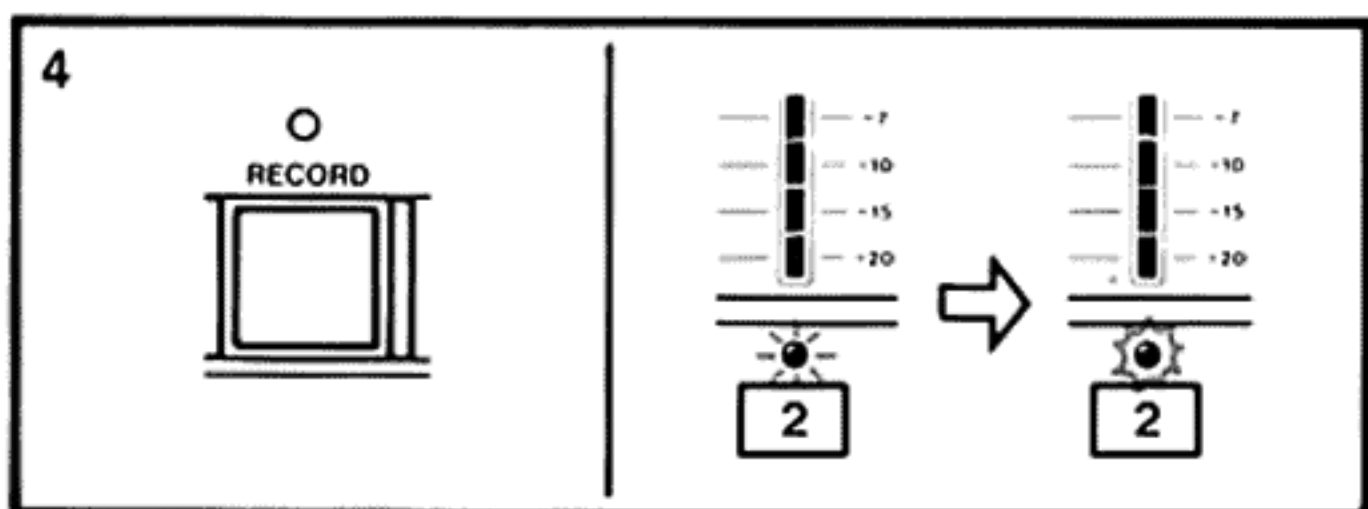
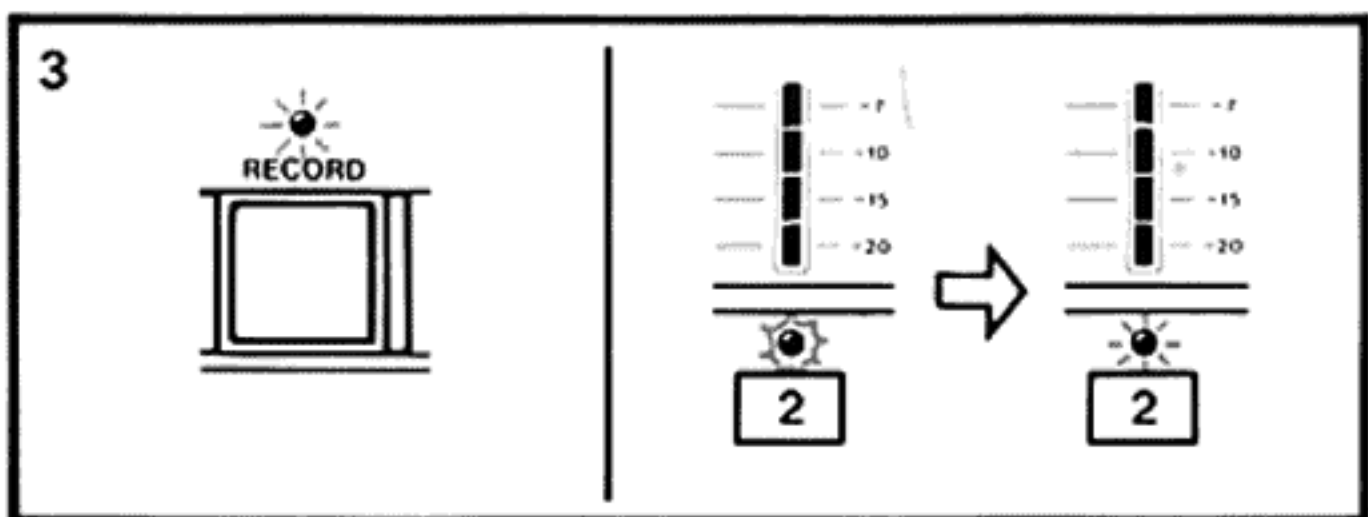
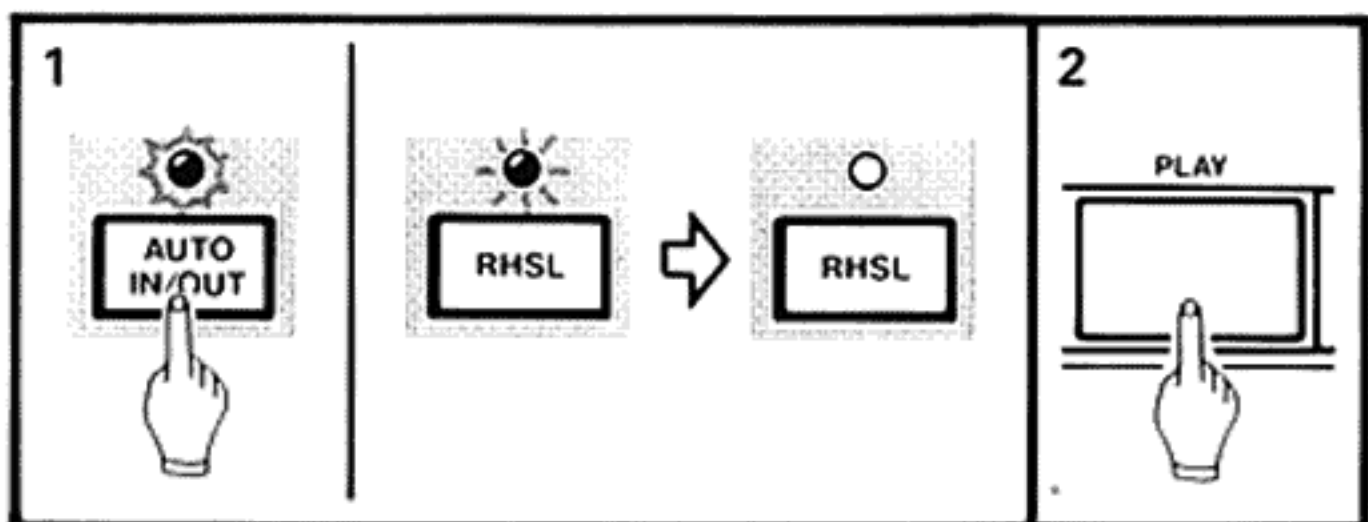
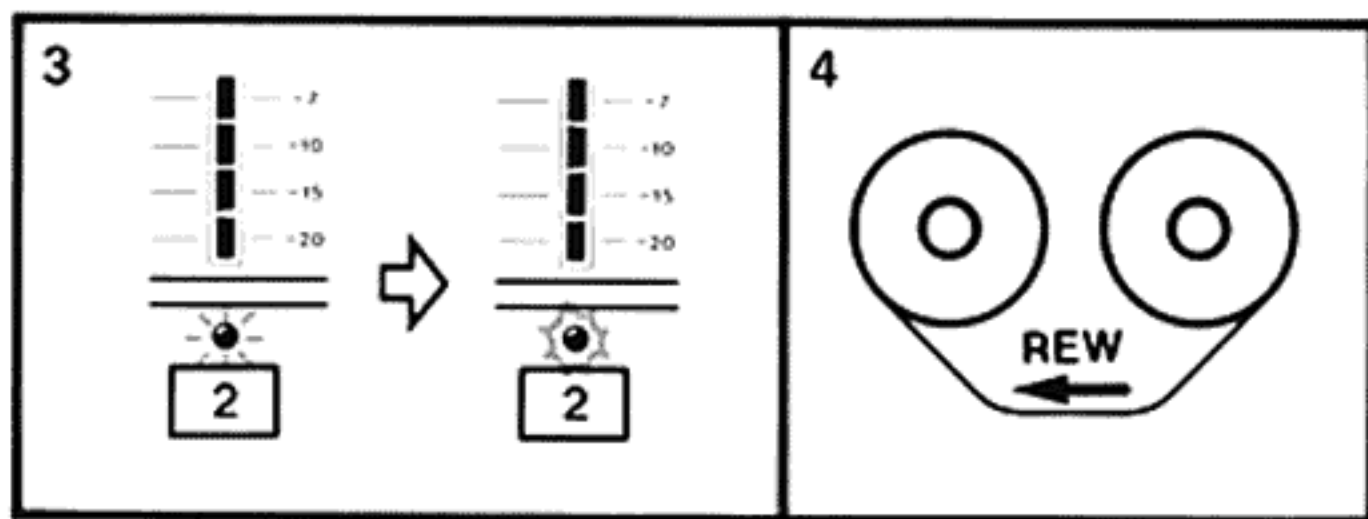
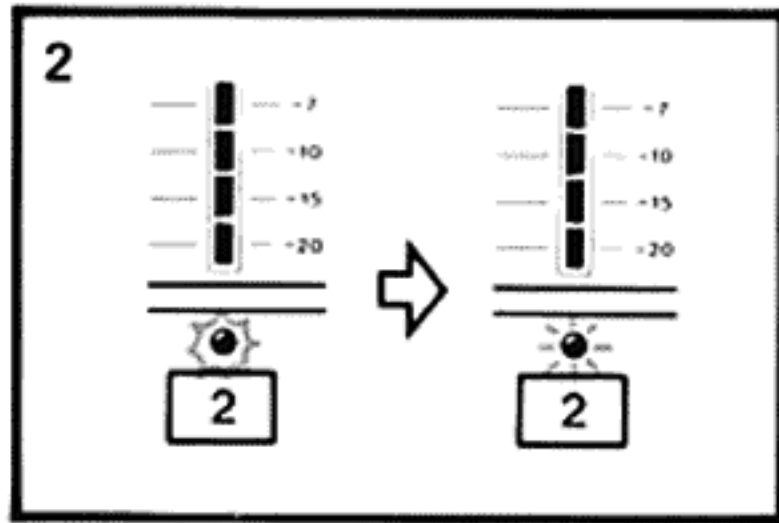
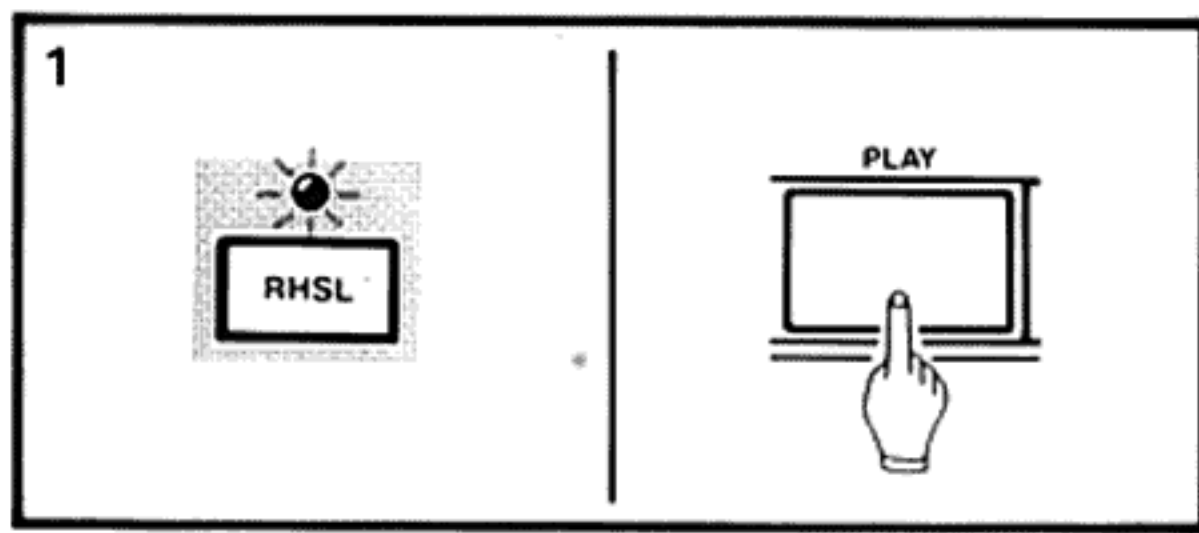

Rehearsing the Punch-in ("Dry Run")

1. Make sure that the TSR-8 is in "Rehearsal Ready" mode with the punch-in and out points memorized and the RSHL LED on solid. Press PLAY or the RC-30P footswitch. The TSR-8 will begin playing from the preset start point.

2. When the tape reaches the preset punch-in point, the track's output will switch from tape to source. The LED for the punch-in track stops blinking and stays on, although recording is not yet taking place. Your live instrument can be heard from the output of the track.

3. When the tape reaches the punch-out point, the track's output will switch back from source to tape. The LED for the punch-in track will start blinking, indicating that the "dry run" record is over.

4. After a 3-second postroll, the tape will automatically rewind to the preset start point, ready for as many rehearsals as you wish.

Practice the performance until you are sure that you will get it right when actually recording. Remember, once you punch in over existing material, that original signal is erased.

Actual, Auto Punch-In

Once you're sure your performance and the punch-in/out points selected are correct, you're ready to actually record the insert. The INSERT and RSHL LEDs should still stay on. All tracks should be in SAFE except the ones you intend to record.

1. Press the AUTO IN/OUT switch. A red LED will begin blinking above the AUTO IN/OUT switch, while the RSHL LED that was on solid will turn off, indicating that the TSR-8 is switched from REHEARSAL mode to actual, automated "punch-in ready" mode.

2. Press PLAY or the footswitch to begin the preroll from the preset point.

3. When the tape reaches the preset punch-in point, the punch-in track will automatically enter actual record mode; and the RECORD and Track LEDs will turn on solid. New material is being recorded, erasing the original part.

4. When the tape reaches the memorized punch-out point, the TSR-8 punches out of Record. The RECORD LED will turn off and the track's LED should again be blinking.

5. After a 3-second postroll, the AUTO IN/OUT LED that was blinking will turn on solid and the tape will automatically rewind to the memorized start point.

To review the result, press PLAY or the footswitch. The tape will play the entire segment and rewind to the start point.

To record again using the same memory points, press the AUTO IN/OUT switch again (its LED will again blink), then press PLAY.

To terminate the Auto In/Out procedure, press the CLEAR switch. The AUTO IN/OUT LED which was on solid will turn off. By hitting CLEAR, you erase all of the three memory points (Preroll Start, Punch-in and Punch-Out points).

About Punching In

Setting in and out points: For both musical and technical reasons, when punching in or out of a track, you must select points that are "in the clear", i.e., in the pauses between phrases or notes. It sounds unnatural and makes the insert noticeable if you record a new note before the old one has ended, or are holding a note as you punch in or out. For this reason, some session players leave a beat or two of silence between passages they might want to edit later. Making inserts well requires some practice. Many engineers count bars and beats to keep track of the punch in and out points and hit them on cue. Because of the spacing between the erase and record heads, you may need to anticipate your

in/out points by a fraction of a second for extremely tight cues though the gapless operation and high speed of the TSR-8 makes it much easier.

External computer punching: If you need insert points that are consistently repeatable within 1/30th of a second, you may want to control the TSR-8 by an external computer device. With this method, track 8 is recorded with SMPTE time code and punch-in/out points are entered into the TSR-8 via the serial connector on the back panel. The procedure is similar to the TSR-8's built-in AUTO IN/OUT function but more accurate because the computer is reading a reference actually recorded on tape instead of tach pulses generated by the movement of the tape reels.

Level matching: No matter how carefully you set your punch points, if the inserted material is louder, softer, or a different tone from the original track, it will be noticeable. Set the EQ and volume settings on your mixer the same as they were during the original recording. If you make inserts immediately after recording, don't change the instrument or mixer settings at all. Keep in mind that at a certain point it's better to record the whole track over than making multiple punch-ins.

7. BOUNCING TRACKS (PING-PONG)

The recording capability of the TSR-8 is not limited to the eight tracks. As you progress with recording, you may reach a point where you need more than eight tracks of material. This is where Bouncing — also called Collapsing or Ping-ponging tracks — is invaluable. Essentially, bouncing tracks consists of a "mini mix-down": taking tracks that have already been recorded,

making a mix of these tracks and re-recording them back onto an empty track (or tracks) of the TSR-8.

With all multitrack recorders, it is possible to get feedback when a track is recording signal being bounced from the track right next to it. To eliminate feedback, it is advisable to bounce on a track away from the originals.

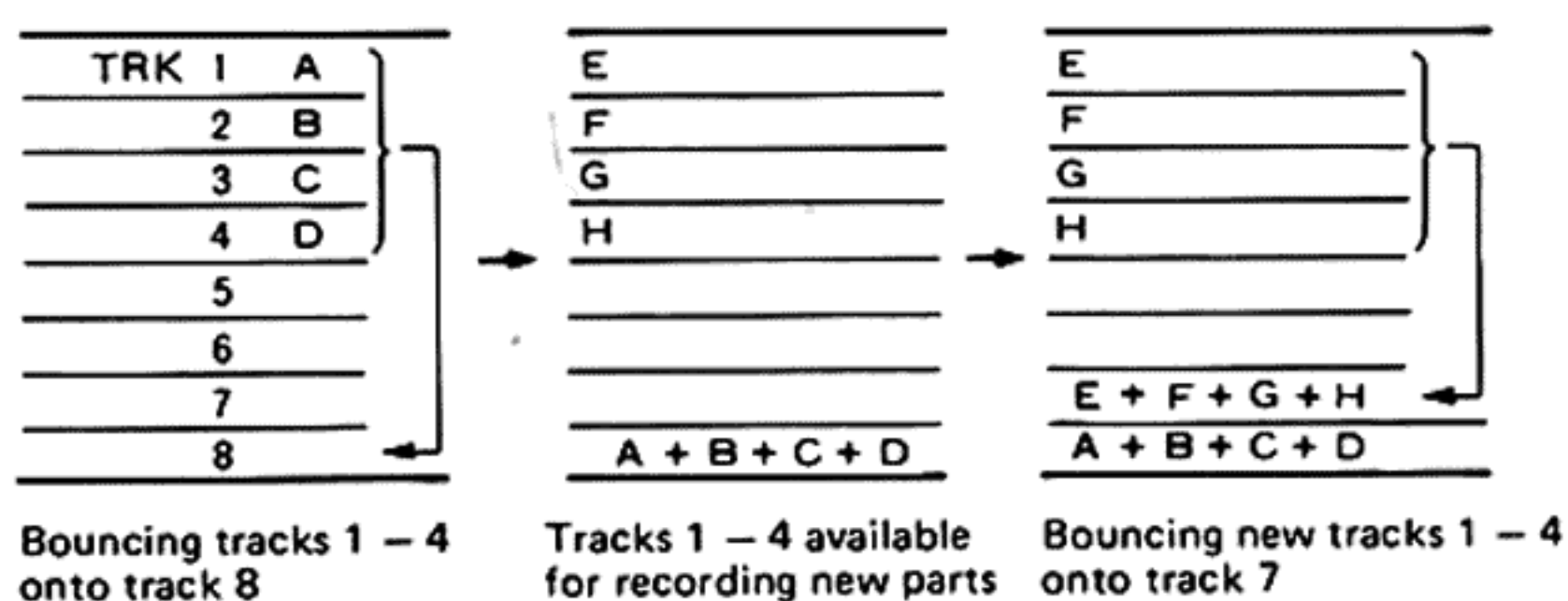

Other Tips About Bouncing

1. Before you record over the parts that have been bounced together, make certain that you're happy with the overall sound of the bounced parts, because you won't be able to change their mix or punch-in to fix errors.

2. It is possible to bounce tracks more than once, i.e., to take a bounced track and combine it yet again with other material onto another empty track. There are limits, however, just as there are anytime you make a copy of a copy. Eventually the sound will get "blurry" — treble will be decreased and added dropouts will become more noticeable. Whether the added versatility

of bouncing is worth the slight loss of sound is up to you and the demands of your project.

3. It is also possible to add new, previously unrecorded parts to the bounced material, for example to take Tracks 1-4 and mix them with additional "live" sounds onto Track 5.

4. Certain material lends itself to bouncing — vocal backgrounds, layered keyboards, etc. Main parts of the program such as lead vocals and instrumental solos are best left on their own tracks so you can control them in the final mix.

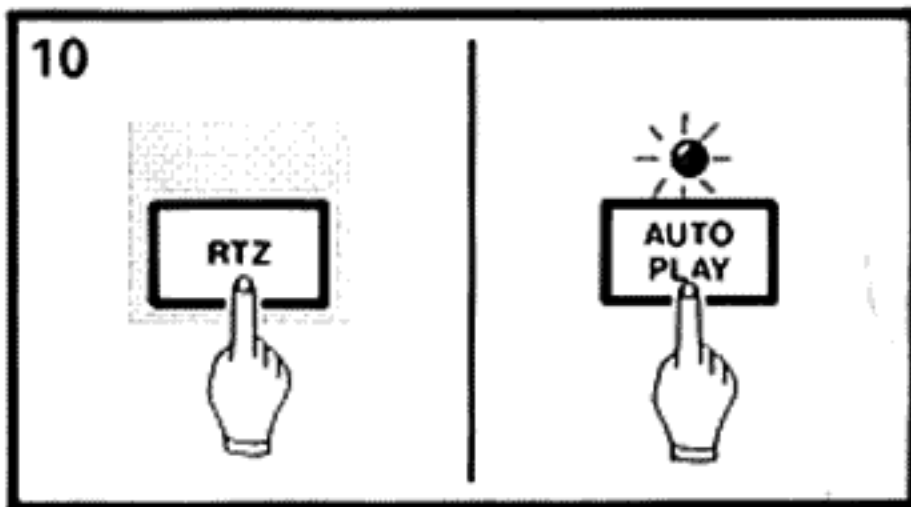
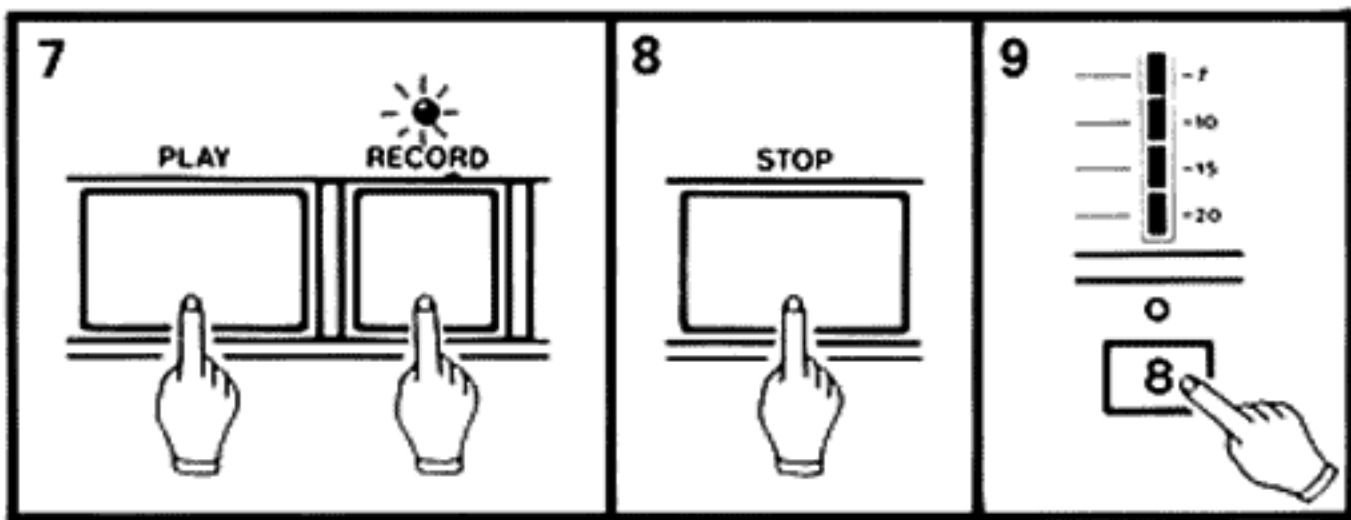
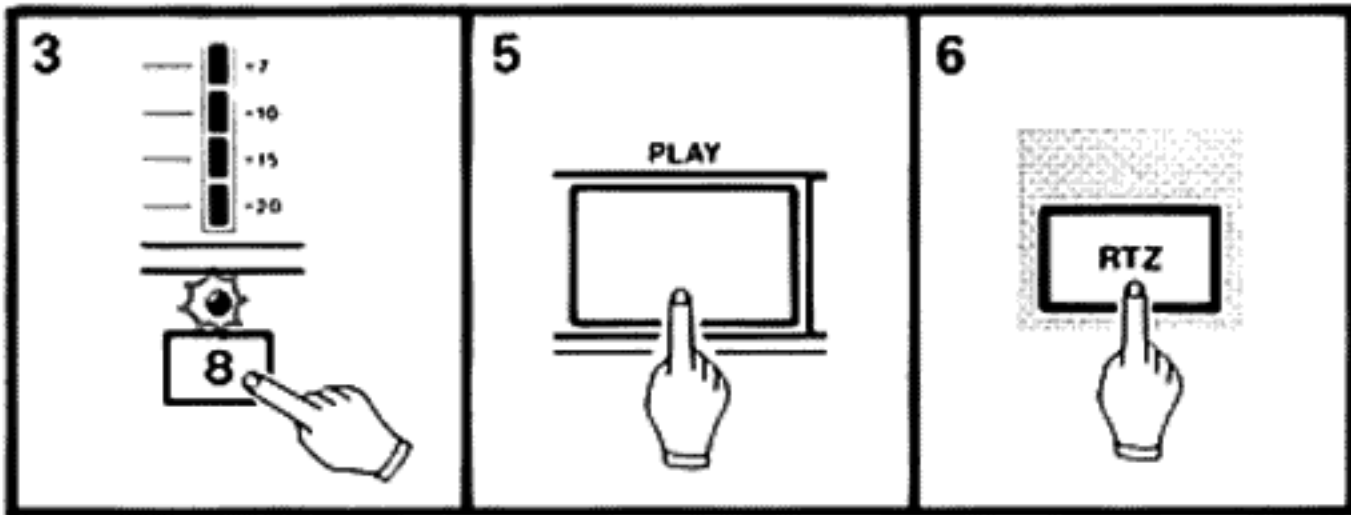
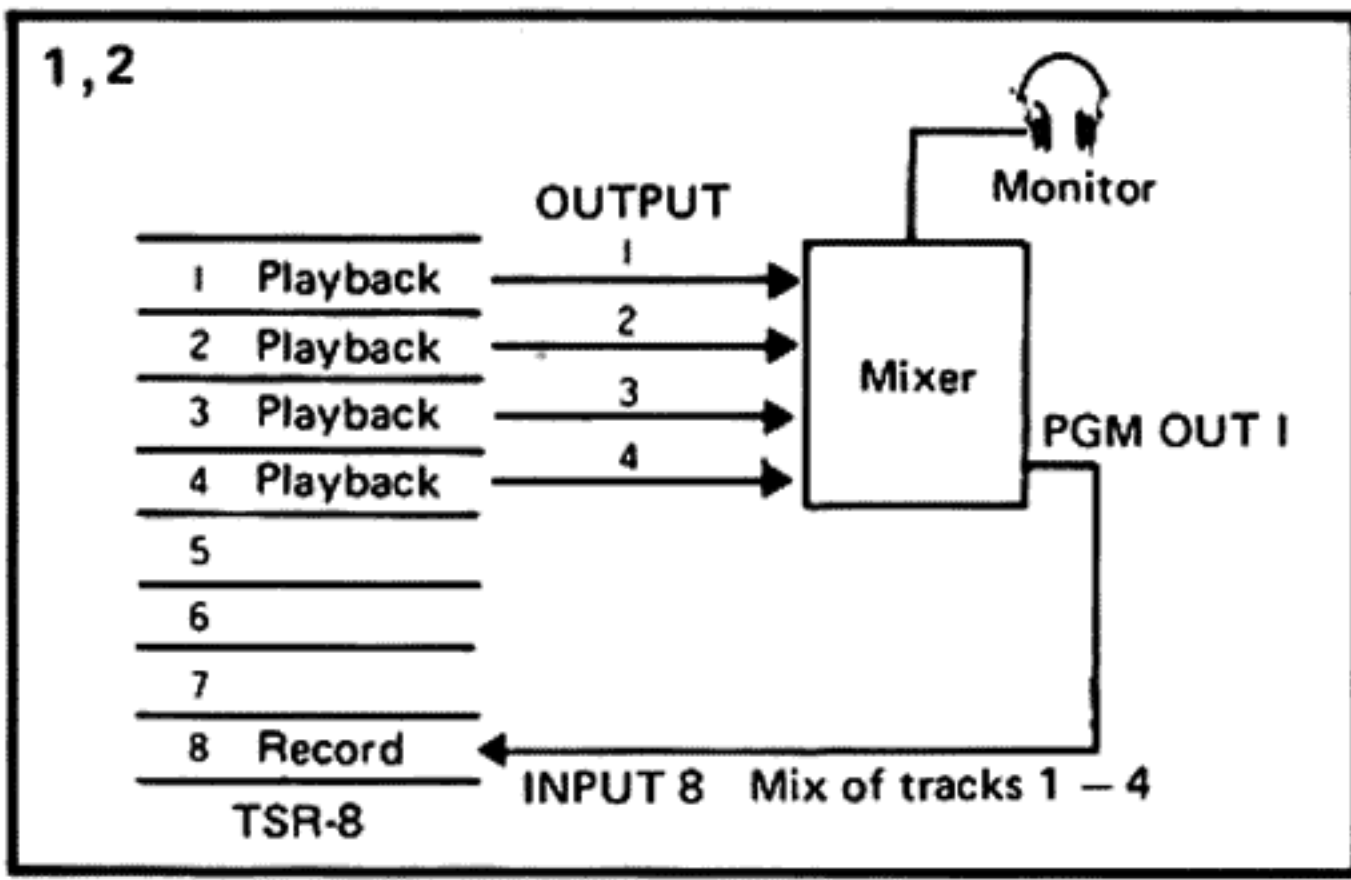

Bouncing: Example

Let's take the contents of tracks 1-4 and bounce them to track 8.

1. Set your mixer so that the main input channels 1-4 are receiving the TSR-8's tape outputs.

2. Assign channels 1-4 to the group output on the mixer connected to track 8 of the TSR-8.

3. Press the Track 8's Record Enable button (Record Ready Mode). Its LED will start blinking.

4. Make sure that the monitor section of your mixer is receiving the output from track 8 and nothing else. All other signals feeding the monitor should be turned off. This gives you an accurate monitor of the mix you're actually bouncing.

5. Start playing the tape. Slowly raise up the channel faders 1-4, and the master fader of the program group the channels are assigned to. Get the balance you want from the channel faders, then adjust the master fader for overall level until you get proper meter readings on the TSR-8.

6. Press the RTZ button to rewind the tape to counter 00.00.

7. Press PLAY and RECORD to begin recording.

8. Stop recording by pressing STOP or PLAY.

9. Press the track 8 Record button to prevent accidental erasure of the track.

10. Press RTZ then AUTO PLAY to hear the result. Make sure you've got a mix that you want to keep. If so, you're free to record over the old tracks; if not, make whatever adjustments that are necessary on your mixer and try it again.

8. MIXDOWN (REMIX)

Once all the tracking and overdubbing is complete, it will be time to mixdown to stereo. At this point, the TSR-8's tracks should all be in safe mode, and the main input channels of the mixer should be switched to receive signal from the TSR-8. The stereo outputs of the mixer should be connected to your 2-track recorder, and your monitor "where from" switch should be switched to receive signal either from the 2-track outputs or the stereo output of the mixer.

NOTES:

1. If you recorded the 8-track tape with DBX noise reduction, you should play it back with DBX on. DBX is an encode/decode process. It is not possible to get a "DBX mixdown" by defeating the noise reduction on playback, mixing encoded tracks to stereo, and then playing back the 2-track master through a DBX decoder.

2. Once outputs of the TSR-8 have been decoded by the DBX unit within the TSR-8 they behave like any other audio source, and can be mixed down to any medium: digital tape recorders, cassettes with Dolby B, C or DBX noise reduction, or the audio tracks of a VCR.

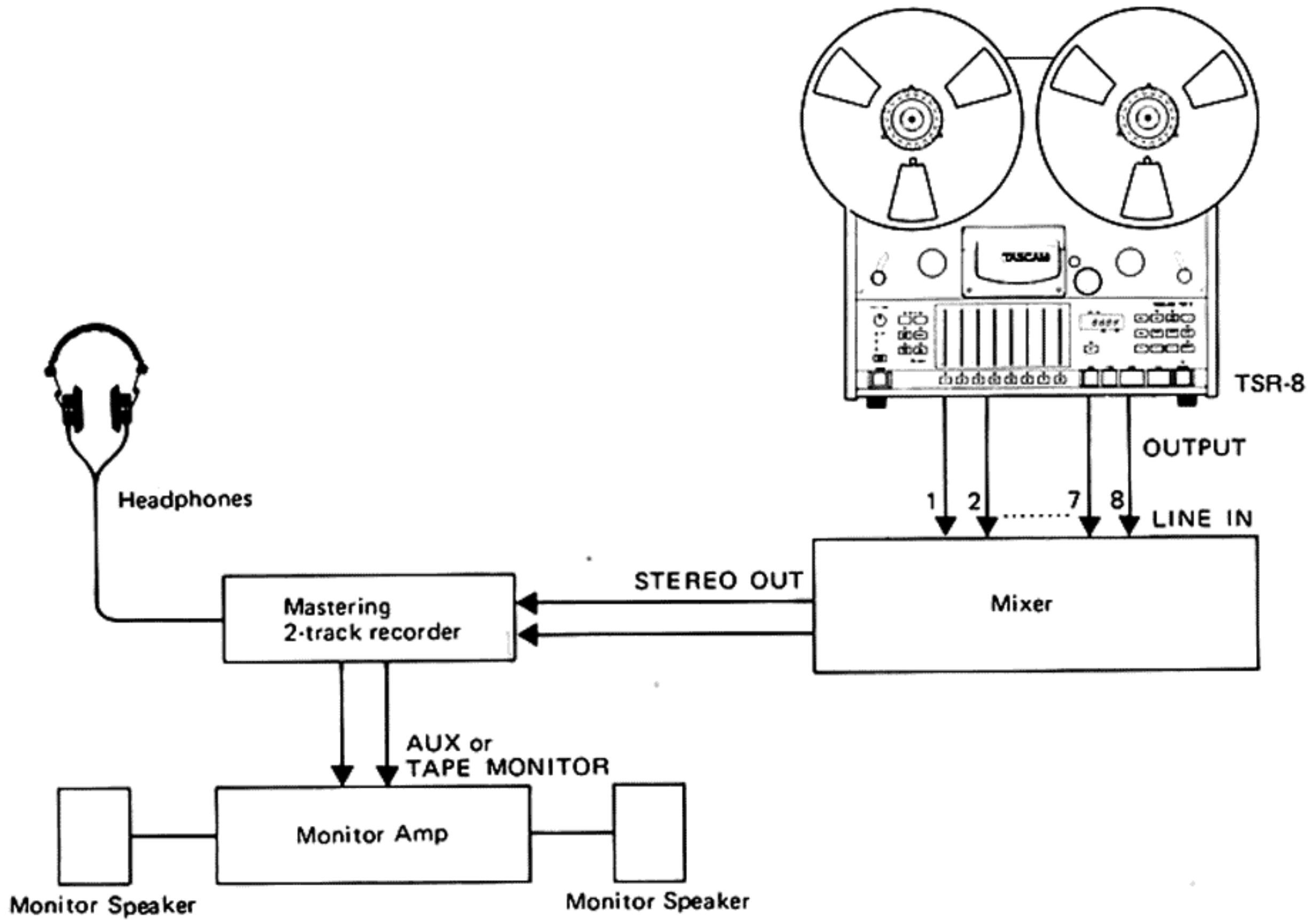

9. RECORDING WITH TAPE SYNC

Your TSR-8 has special features designed to make it an ideal recorder for use with electronic musical instruments. Track 8 is specifically designed to be used with the recordable synchronizing codes used by MIDI (Musical Instrument Digital Interface) as well as the SMPTE time code. Since MIDI itself is a computer type digital language and cannot be recorded on analog tape, it is necessary to convert MIDI timing clocks to recordable FSK (Frequency Shift Keying) signals using a MIDI/FSK converter such as the TASCAM MTS-30. Sometimes this type of converter is built into sequencers, drum machines and computer interfaces.

If you record the sync tone at the same time as instrument tracks, processing delays in some sequencers may cause phasing or timing lags during Playback. It's good practice to record the sync tone *before* recording instruments to tape.

- Connect the FSK output (labeled "Sync Out" or "Tape Out") of your sequencer, MIDI converter, or computer interface directly to the INPUT of track 8. Do not patch through your mixer. A direct connection between the sync tone generator and the TSR-8 ensures that FSK won't accidentally leak into the audio, and unwanted audio won't leak into the FSK.

- Set the CH8 INPUT REF LEVEL switch on the TSR-8's rear to match the nominal, reference output level of your sync tone generator. If you are using the TASCAM MTS-30, set the switch to the -10 dBV position.
- Press on the Record Enable button of Track 8 (red LED blinking).
- Turn on the SYNC LOCK switch on the front of the TSR-8. This defeats the dbx encode/decode for track 8 only. The SYNC LOCK LED will blink.

CAUTION: *Be sure to press the track 8's Record Enable button BEFORE the SYNC LOCK switch. Otherwise recording is NOT possible on that track.*

- Consult the owner's manual of the device that is generating the sync tone to find out how to start the tone. Most units utilize a "pilot tone" that is output before the unit is started to help you set the level on the tape deck.
- Press RECORD and PLAY. After a few moments, hit START on your sequencer unit. Let the sequence play to its completion without stopping the TSR-8.
- Once track 8 is complete, release the Track Record button by pressing it. Its LED will go out, and the SYNC LOCK LED will go on solid showing that the track is locked to play mode.

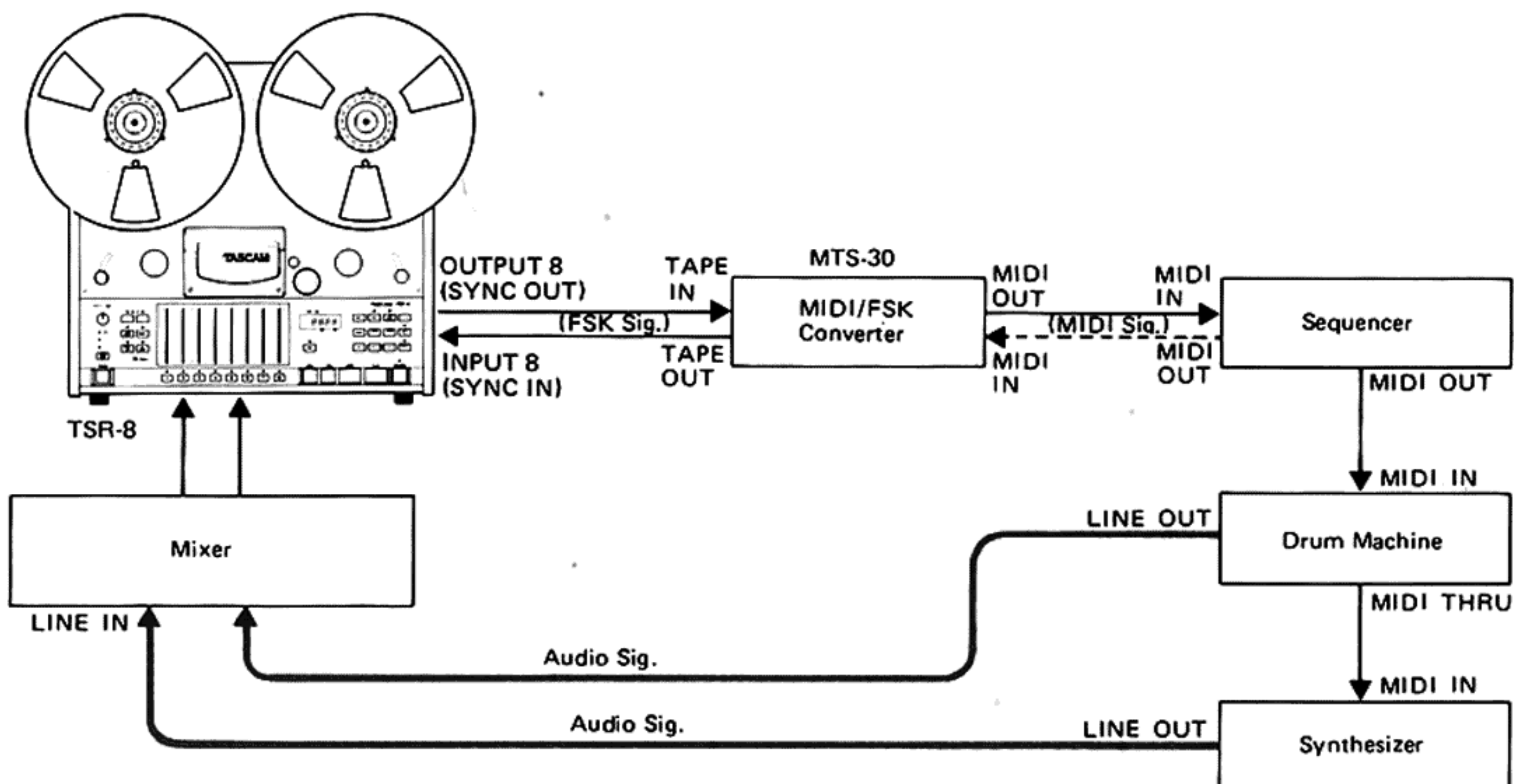

Playback of Sync Tones

- Connect the Track 8 output directly to the Sync in ("Tape in") of the sequencer or MIDI converter. Again, do not patch through the mixer.
- Consult the owner's manual of your sequencer unit for specifics of how to switch it to follow external tape or MIDI clocks, depending on whether you're using a MIDI/FSK adapter.
- Rewind and play the tape. The sequencer or drum machine will start at the correct place on the tape every time and play at the same tempo that was recorded. Or your converter will translate the sync code playing back from track 8 into MIDI clock information which, in turn, will drive the MIDI program in the sequencer or drum machine. In addition, the synthesizers and other sound sources or processors connected to the sequencer will now operate in sync with the tape. In this way you can continue to record other "non-MIDI sound sources" – vocals, acoustic instruments, etc. – on the remaining tracks while listening to the MIDI instruments playing along with the sync track 8.

By following this procedure, the sequencer in effect uses track 8 as a "guide" track to play as many instruments as are being controlled via MIDI from the sequencer, creating "virtual" tracks. You may decide to actually record the audio output of some of those tracks so you can use the instrument in a different way on another track, or you can leave the "virtual" tracks unrecorded until mixdown time. Combining virtual tracks with the normal tracking procedures used in recording makes it possible to record a tremendous number of different instrument sounds on a small number of tape tracks. Your only real limitation is the number of sound sources and the capacity of your sequencer.

About Tape Sync

- It is possible to record onto track 7 while locked to time code or sync tone from track 8 without any problem if you keep in mind that crosstalk is greatest during the overdubbing of track 7, since the record level in the head is 40 dB hotter than it is during playback. The signal of track 7 inductively crosstalks to the head windings of track 8, possibly causing a sequencer to miscue or a synchronizer to drop lock. If this happens, there are a few remedies:

a) Lower the record level of the signal onto Track 7.

b) Insert a 10 or 20 dB pad between Track 8 out and the synchronizer. There is a point with many units where the crosstalk is attenuated below the "confusion threshold" of the code reader, but there is still enough level on the time code for it to be read.

c) Consider recording track 7 while the virtual tracks aren't locked up. In playback, the crosstalk returns to a normal level, and you can lock up to track 8 again. If you record code and sound simultaneously, record tracks 7 and 8 at the same time ... there is no sync crosstalk if 7 is never overdubbed onto.

NOTE: Certain types of instruments – percussion or other instruments with extreme transients, synths with pulse waves, etc. – are more likely to cause a reading problem than other instruments.

Features and Controls

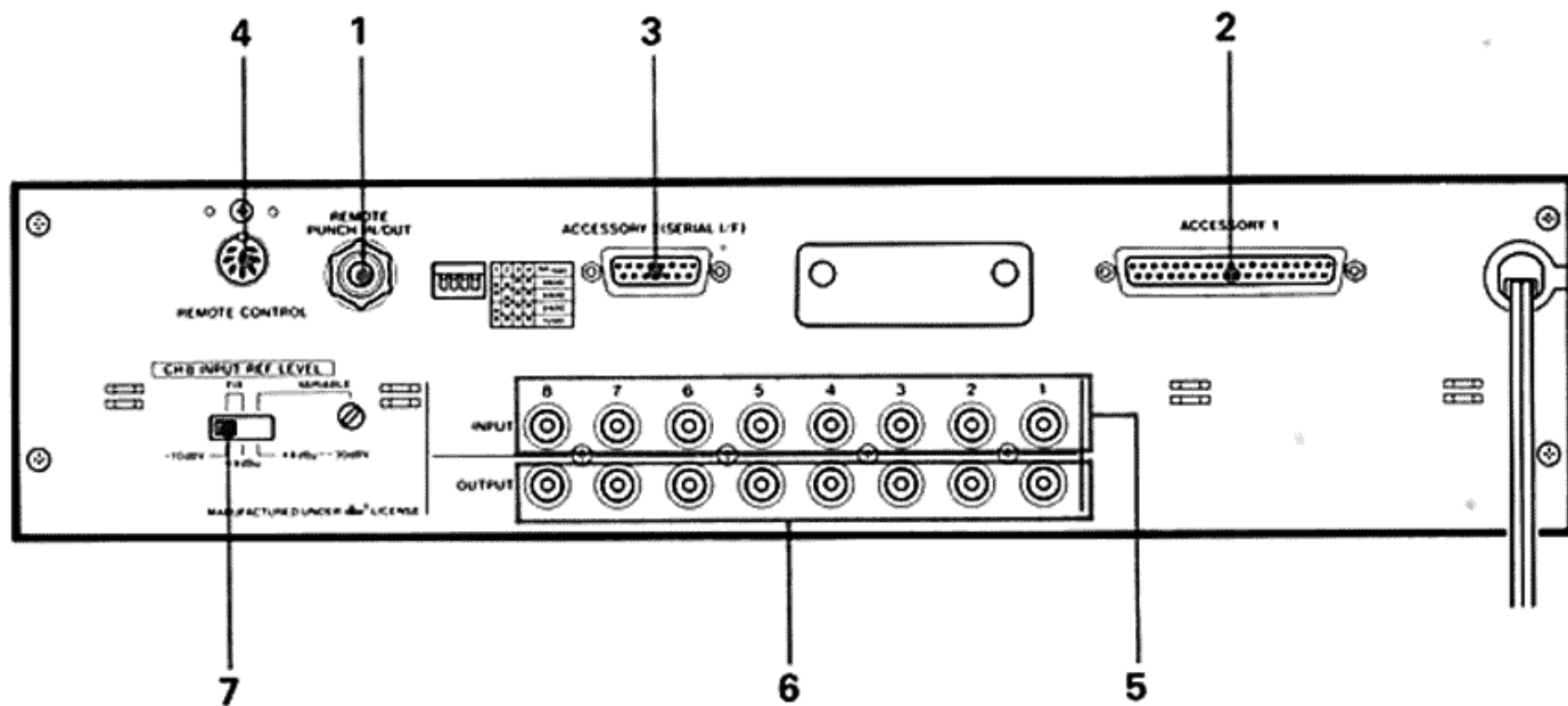
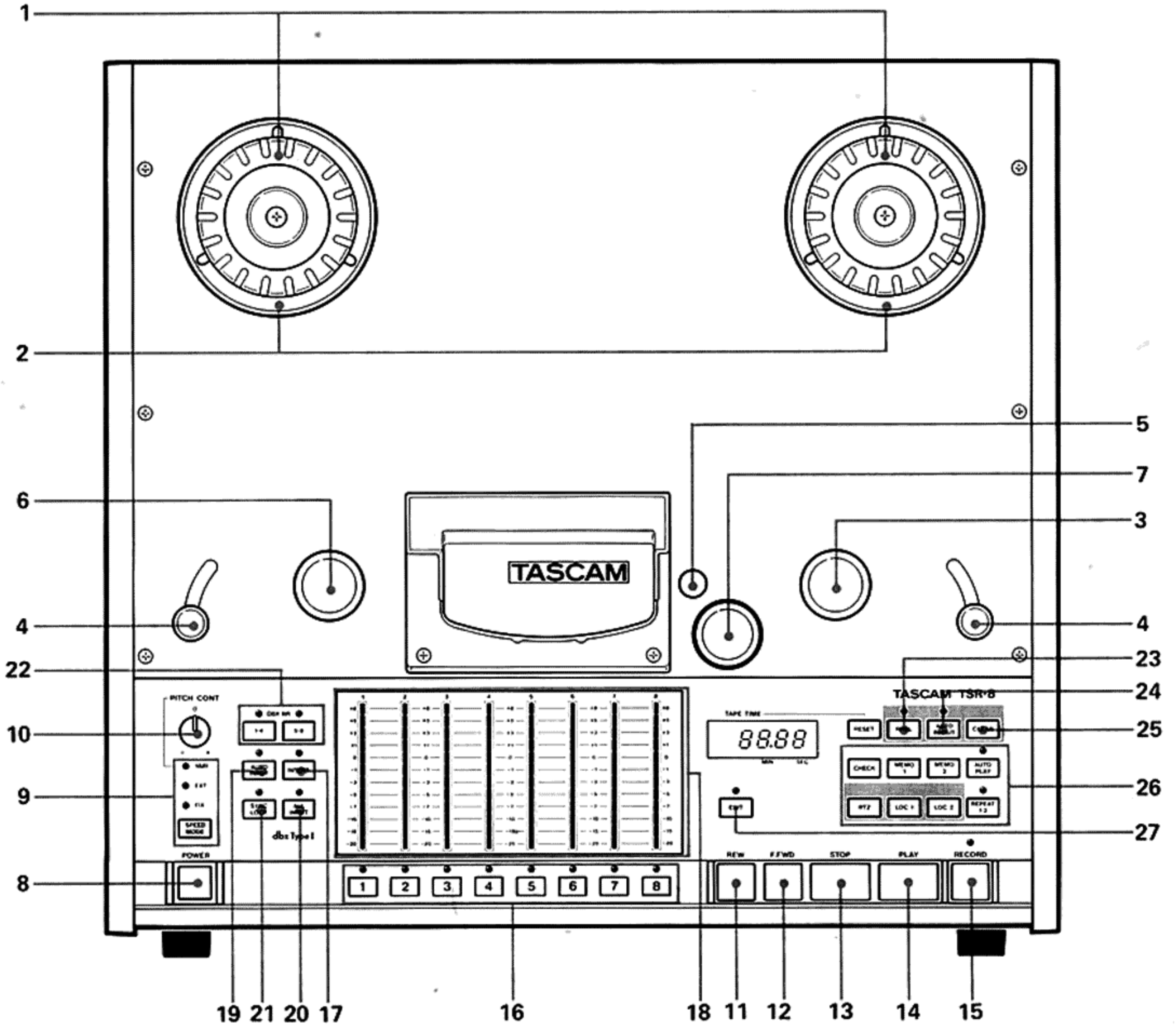

—REAR PANEL—

1. REMOTE PUNCH IN/OUT Jack

This is for connection of the optional RC-30P foot-switch. Whether you're a busy engineer, producer, or a musician with both hands on an instrument, there are times when you can't drop what you are doing to press RECORD button. The RC-30P is the solution. It lets you punch-in and out of Record with a tap of your foot.

2. ACCESSORY 1 Connector (37-pin, D-sub)

It has the inputs/outputs necessary for the direct interface with the TASCAM ES-50 Synchronizer or other SMPTE/EBU Synchronizers/controllers. ACCESSORY "1" is a parallel port, as opposed to the ACCESSORY "2" connector.

3. ACCESSORY 2 (SERIAL I/F) Connector (15-pin, D-sub)

This is a serial I/O port conforming to the RS-232C standard for linking the TSR-8 to an external computer, or synchronizer such as the TASCAM MIDiiZER.

The dip switch adjacent to the connector is used to select the bit rate (data transmission speed) as per the diagram beside the switch.

4. REMOTE CONTROL Connector (8-pin, DIN)

This is for connection of the optional RC-408 remote control unit. With the remote control unit, you can control all tape motion from a distance of up to 15 ft (5 m).

5. INPUT Jacks 1-8

Each of these RCA jacks accepts a nominal input level of -10 dBV (0.316 V). The input impedance is 10 kOhms (unbalanced).

6. OUTPUT Jacks 1-8

These outputs carry either the tape signal of the corresponding track, or the source (input) signals, depending on the position of various front panel controls. See the switching logic table on page 27.

The TSR-8 has no output level controls of its own and the output level is the same as the input level; that is, -10 dBV (0.316 V). The output impedance is 100 Ohms (unbalanced).

7. CH8 INPUT REF LEVEL Selector Switch

Normally, set this switch to the -10 dBV (0.316 V) position to match the input reference level of the remaining channels, 1 - 7.

When you record track 8 with sync tones or time codes you can use the switch to set for +4 dBu (1.23 V) or any level between +4 dBu and -30 dBV (0.03 V) in pursuant to the sync tone/code generator in use.

Settings of the switch have effect only on track 8.

—FRONT PANEL—

1. Reel Holddown Knobs

These are permanently mounted, and are used for the installation of large hub 10.5-inch reels. Clockwise rotation of the knobs tightens the reels in place.

2. Reel Tables

Support 10.5-inch reels/half-inch tapes. Use the same

size and type of reels for both the supply and takeup sides.

3. Guide Roller

Correctly positions the tape along its path.

4. Tension Arms

The capstan servo controls the tape tension and motor torque through the use of a position sensor attached to the right tension arm. The right tension arm is also associated with a shut-off mechanism that stops all tape motion if the tape slackens or spills off the reel. The left tension arm compensates for slight irregularities in the supply reel in addition to maintaining even tape tension.

5. Capstan Shaft and Motor

6. Counter Roller

This measures linear tape footage, which is converted into elapsed time from whatever zero point is entered. The counter roller is associated with a tach generator to provide information about tape motion to external synchronizers during fast wind movements.

7. Pinch Roller

The TSR-8's pinch roller is a "self-centering" type for maximum tape motion consistency. A rubber coating on it is of urethane for maximum resistance both to wearing and to cracking or hardening.

8. POWER Switch

Controls AC power to the TSR-8. Pressing POWER a second time turns the machine off, and clears the MEMO 1, MEMO 2, Punch-in Rehearsal (RHSL), and AUTO IN/OUT memories.

9. SPEED MODE Selector Switch

This switch selects either FIX or VARI mode. The setting of the switch is defeated as soon as external specific signals are fed into the TSR-8 via its rear panel ACCESSORY 1 or 2 connector in which case the EXT LED will automatically turn on.

FIX: Locks tape speed to 15 ips (38 cm/s). Setting to FIX is indicated by a green LED.

VARI: Switches tape speed control to the PITCH CONTROL. "Non standard" tape speeds can then be used. Setting to VARI is indicated by a red LED.

When the TSR-8 capstan motor is under external control of a synchronizer/controller the EXT LED will light steadily in yellow. When either the control signal or 9.6 kHz reference to the TSR-8 is interrupted, the EXT LED will flash and the FIX LED will turn on solid, indicating that the FIX speed mode is active, as summed up in the table below.

FIX LED	EXT LED	ACCESSORY 1 (Parallel)		ACCESSORY 2 (Serial)	
		Ext. Cont.	9.6 kHz	Ext. Cont.	9.6 kHz
On Solid	Off	None of the above four signals is coming			
On Solid	Flash-ing	Only one of the four signals is coming			
Off	On Solid	Either pair of the signals (control and frequency reference) is coming			

10. PITCH CONTROL

When and only when the SPEED MODE selector switch (#9) is in its VARI position and its red LED is on solid, the PITCH CONTROL is active and provides a stepless plus or minus 12% variation to the capstan motor speed both in Record and Play modes. Turn the knob to the left to lower the motor speed, or to the right to increase the motor speed.

You can use this speed control to accommodate minor changes necessary in the length or relative pitch of your program material. If you're making a 30 second radio commercial and it runs a little long, you can speed it up enough to drop out the extra seconds, although the material on it will raise in pitch. This can sometimes be used in a creative way to save parts that are a little out-of-tune, or to create sound effects such as flanging. If you record with the PITCH CONTROL at its maximum or minimum settings, you will NOT have the ability to make further adjustment in that direction upon playback.

Before beginning to record again, check the pitch carefully with a short playback, and you will have less troubles with drift.

CAUTION: The PITCH CONTROL affects the record speed also. Check to make sure that SPEED MODE select switch is set to FIX unless you are using the PITCH CONTROL intentionally.

11. REW(ind) Button

Pressed, winds tape at high speed in reverse.

12. F.FWD Button

Pressed, winds tape at high speed in the forward direction.

13. STOP Button

Stops any tape motion, and cancels all transport modes.

To cancel RHSL and AUTO IN/OUT modes, use CLEAR. If STOP is used instead, the LED RHSL or AUTO IN/OUT blinks, not turns off though those functions are actually disabled, and to turn off the LED you have to press CLEAR anyway.

14. PLAY Button

- Pressing this button alone starts tape playback.
- Pressing the button while recording stops the recording ("punch out") without stopping the tape motion.

15. RECORD Button

Pressing the RECORD button together with the PLAY button will cause either of the following two events:

- If any Track Record buttons are engaged, the LED above them as well as the RECORD LED will stay on, and recording will begin on the corresponding tracks.
- If none of the Track Record buttons is engaged, the master RECORD LED will blink to indicate a record ready.

Pressing the RECORD button alone during the tape is rolling in PLAY will enable a punch-in ("insert").

The RECORD LED conveys the following messages:

- LED off: safe mode – no recording is taking place.
- LED blinking: record ready mode – tape is rolling at play speed, but no actual recording is in progress. Recording will start as soon as any Track Record button or buttons are pressed on.
- LED on solid: record mode – recording is taking place.

16. Track Record Buttons

Pressing any of these eight buttons puts the corresponding track into Record-Ready, or directly into Record mode if RECORD and PLAY have already been pressed.

Functions of the Track Record LEDs

- LED off: Safe – recording cannot occur on that track.
- LED blinking: Record Ready – recording on that track will occur when RECORD and PLAY are pressed.
- LED on solid – recording on that track is in progress (RHSL or actual).

17. INSERT Switch

INSERT determines what signal (source or tape) appears at the output of tracks placed into record ready mode by the Track Record buttons. It allows automatic monitor switching from tape to source during punch-in, and back to tape at punch-out.

- When INSERT is ON, the output of any tracks whose LEDs are blinking (in record ready mode) will be Tape.
- When INSERT is ON and RECORD mode is entered (LEDs solid), the output of the tracks being recorded will be source (Input).
- When INSERT is OFF, the output of any tracks whose Record Enable buttons are on will be source (Input) regardless of whether you're actually recording or not.

The INSERT button only affects tracks whose Record LEDs are on. When INSERT is off, you can use the Track Record buttons to manually toggle between tape and source, and rehearse a punch-in.

Switch Setting		Transport Mode		
Track Record Button	INSERT	STOP	PLAY	RECORD
ON	ON	–	Tape	Input
	OFF	Input		
OFF	/	–	Tape	

CAUTION: When performing Spot Erasures also, the INSERT switch MUST BE ON, so you can hear the output of the tape to find the erase point. (See page 30.)

18. Peak Level Meters

These meters register the signal levels being fed to the TSR-8's OUTPUT connectors, in the limits of -20 dB to +8 dB.

19. AUTO INPUT Button

This feature automatically switches the output of tracks in REC READY mode to input during REW, F.FWD or STOP. This allows the control room to hear the talent through the tape monitor for communication, without having to change any settings on the mixer.

20. ALL INPUT Button

When ALL INPUT is pressed on, all the channels' output will carry signals derived from the input electronics regardless of the transport mode.

21. SYNC LOCK Switch

SYNC LOCK is used to "lock" track 8 to playback mode so sequencers or synchronizers can constantly read sync signals (FSK or SMPTE time codes) played back from that track. Another function the switch provides is to turn off the DBX on track 8 only, enabling sync signals to be recorded and played back without being affected by the dbx encode/decode

When recording sync signals on track 8 be sure to press the SYNC LOCK switch AFTER the track's record enable button. A red LED will then start blinking above the SYNC LOCK switch to indicate that the DBX on track 8 is disabled.

CAUTION: If the SYNC LOCK switch is pressed when the track 8 button is in its OFF position, the SYNC LOCK LED will turn on solid, instead of blinking, to indicate that the track is "locked", and pressing the track button has no effect and any recording can't start on that track.

Once track 8 is complete, release the track button by pressing it again. This will cause the SYNC LOCK LED that was blinking to turn on solid. As the LED is on solid, the track will NOT switch to Input, regardless of the settings of ALL INPUT or AUTO INPUT.

The track 8's status is determined by the following logic.

Switch Setting		Track 8 Status	
Record Enable Button (track 8)	SYNC LOCK Switch	Recording	DBX System
ON (LED flashing or on solid)	ON (LED flashing)	Possible or Currently in progress	Ineffective*
	OFF (LED off)	Possible	Effective or Ineffective**
OFF (LED off)	ON (LED on)	Impossible	Ineffective*

*) Regardless of the setting of the DBX switch

***) Depending on the setting of the DBX switch

22. DBX NR On/Off Switches, 1-4 and 5-8

When these switches are engaged, their LEDs will light and the built-in dbx noise reduction system for each group of channels (1-4 and 5-8) is turned on. This system provides a noise reduction of about 30 dB and increase of tape saturation level (headroom) of about 10 dB, resulting in a dynamic range of more than 100 dB.

When the SYNC LOCK switch is engaged, the dbx system for track 8 is disabled, as shown in the table above.

23. RHSL (Rehearsal) Button

RHSL is the first stage of an automatic punch-in recording. During Rehearsal Set mode (RHSL LED blinking), the TSR-8 memorizes the preroll, punch-in, and punch-out counter locations that are used for rehearsals and for AUTO IN/OUT.

When the desired Rehearsal points are memorized and the RHSL LED is on solid, the TSR-8 is in RHSL Ready mode, and pressing PLAY or footswitch will start a rehearsal loop. After a 3-second postroll, the tape will rewind, stopping at the preset preroll start point. The TSR-8 will again be in RHSL Ready mode. You can repeat the rehearsal sequence as many times as you wish.

In the above Rehearsal mode, the RHSL function (in combination with the INSERT feature) switches the output of tracks in record ready mode from tape to source and back again at the preset points BUT NO SIGNAL WILL BE RECORDED TO TAPE. This allows you to hear what a punch-in will sound like before you actually record it, without having to manually press any keys or footswitch.

24. AUTO IN/OUT Button

After you have set the tape's preroll start, punch-in, and punch-out points in RHSL mode, entering the TSR-8's AUTO IN/OUT mode puts it into a ready status to commit the record Punch to tape. Pressing PLAY or the RC-30P footswitch initiates the actual recording by activating the automatic Punch-In/Punch-Out sequence (Preroll, Punch-In, Punch-Out and Postroll).

25. CLEAR Button

This is used to turn off the RHSL and AUTO IN/OUT functions.

Pressing CLEAR during any other modes than RHSL and AUTO IN/OUT has no effect.

26. Auto Locator Section

Grouped to this section are the following:

- 1) MEMO 1 and 2
- 2) CHECK
- 3) LOC 1 and 2
- 4) REPEAT
- 5) RTZ
- 6) AUTO PLAY

1) MEMO 1 and MEMO 2 Buttons

These buttons are used to establish 2 autolocation points in the TSR-8's memory system. They can be used while the tape is stopped or rolling. Pressing either button at any point on the tape loads the current tape location into that memory register. Each time the button is pressed, a new MEMO point is established, erasing the previous memory in that register. Neither

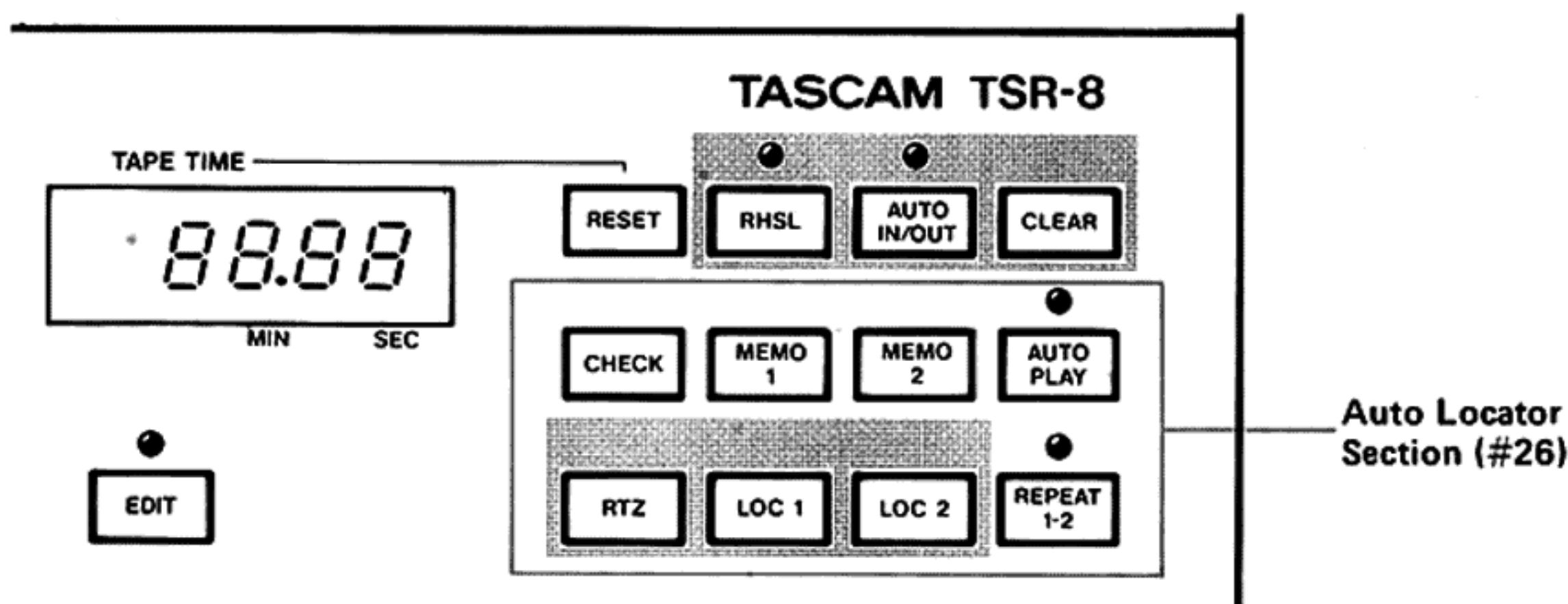

MEMO location can be used if the TSR-8 is in RHSL or AUTO IN/OUT mode. Both MEMO points are erased when power is turned off.

If the RESET button is pressed, and the counter is set to 00.00, the two MEMO points are automatically recalculated, so they stay the same relative to their original tape position.

2) CHECK Button

When the CHECK button is pressed, the digital counter shows a broken line. Pressing then the MEMO 1 or 2 button causes the counter to show, for as long as the MEMO button is held pressed down, the content of the corresponding register. As you release the MEMO button, the counter again shows the broken line. A second press of CHECK, switches the counter to the original display (Tape Run Time).

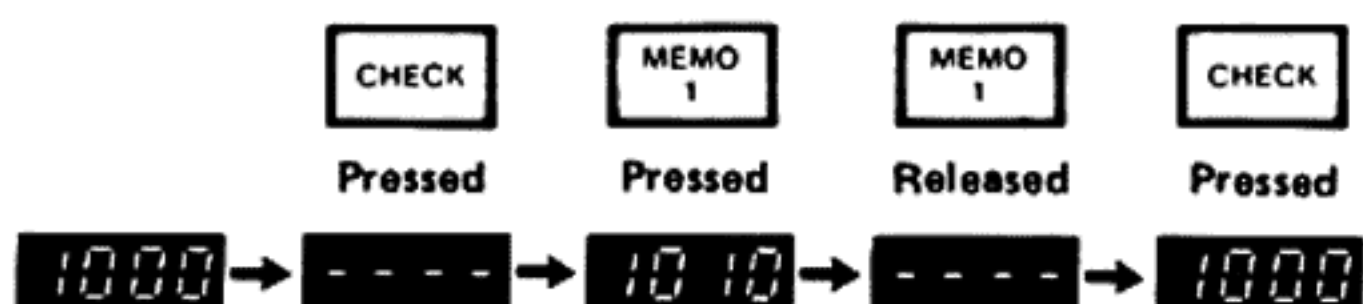

3) LOC 1 and LOC 2 Buttons

Pressing either of these buttons causes the tape to roll (in either F.FWD or REW) to the corresponding MEMO point. The tape will stop when it reaches the MEMO point. If the AUTO PLAY feature is used together, the TSR-8 will enter automatically Play mode after reaching the memorized point.

The LOC 1 and 2 buttons can safely be pressed at any time except during RHSL and AUTO IN/OUT modes; if pressed during these modes, they erase the punch-in memory points.

4) REPEAT 1-2 Button

The REPEAT function provides a "Playback Loop" or "Block Repeat" between the two programmed MEMO points. Note that MEMO 2 does NOT have to be a number greater than MEMO 1. When REPEAT is enabled and the current tape location is between the two MEMO points, the tape will play to the higher MEMO location, rewind to the lower MEMO location and start over. This cycle will repeat until STOP, or any other transport button is pressed.

If LOC or RTZ is pressed when REPEAT is on, REPEAT is cancelled and LOC or RTZ is entered, instead.

5) RTZ (Return to Zero) Button

Pressing the RTZ button will cause the TSR-8 to fast wind (FAST FORWARD or REWIND) the tape to the counter 00.00 point on the tape (even if the display isn't showing the counter). If the AUTO PLAY feature is active, the TSR-8 will automatically enter Play mode after reaching the counter zero point.

During RHSL and AUTO IN/OUT modes also, the RTZ function can be activated, but remember, the punch-in memory points are then erased.

6) AUTO PLAY Button

This feature is used together with the LOC 1 and 2 and RTZ functions. Pressing AUTO PLAY before (or after) RTZ, LOC 1 or LOC 2, will program the TSR-8 to start playback each time after it has located to the counter zero or MEMO points.

27. EDIT Button

The EDIT button provides the following five functions (all of which are disabled when STOP or any other transport buttons are pressed):

1) Manual Edit

When the transport is in STOP and the right (takeup) tension arm is in its "on" position, pressing EDIT will turn its LED on and disengage the reel motor brakes, and the same amount of torque will be exerted on both reels. The reels may then be "hand rocked" to locate the exact edit points.

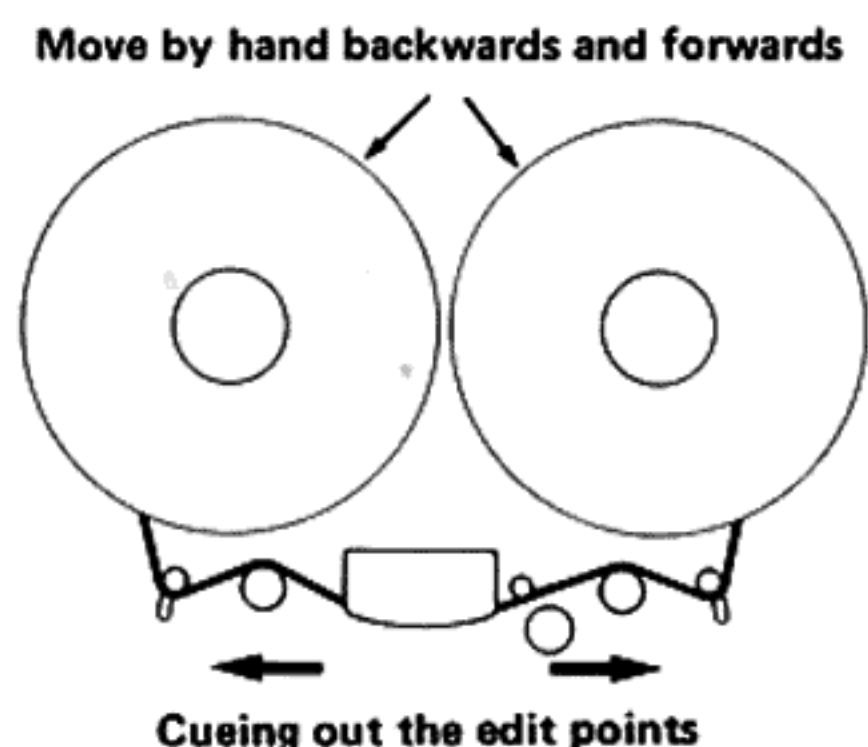

2) Stop Edit

When the transport is in STOP and the right tension arm has dropped to its "off" position, pressing EDIT will turn its LED on and disable the output mute. The tape may then be pulled forward off the supply reel as you listen to it play.

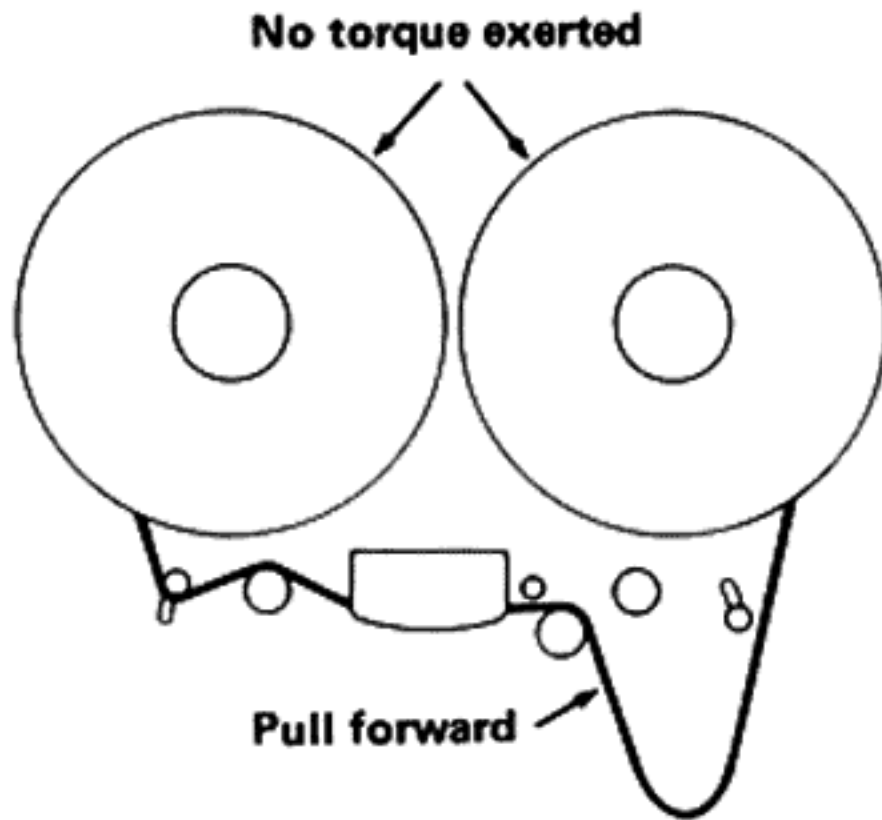

5) Cueing

If EDIT is pressed and held down during the Fast Winding modes (including LOC, RTZ, and REPEAT), the tape lifters will retract so that the tape contacts the heads, enabling high-speed tape monitoring. As the cueing mode is activated, a high-cut filter is automatically inserted to prevent the meter circuits and speaker components from being damaged by high energy audio signals.

3) Dump Edit

If EDIT and PLAY are simultaneously pressed when the transport is in STOP, the EDIT LED will turn on and the tape will begin unthreading from the supply reel as you listen to it play. The right tension arm position is disregarded by the shut-off sensing logic.

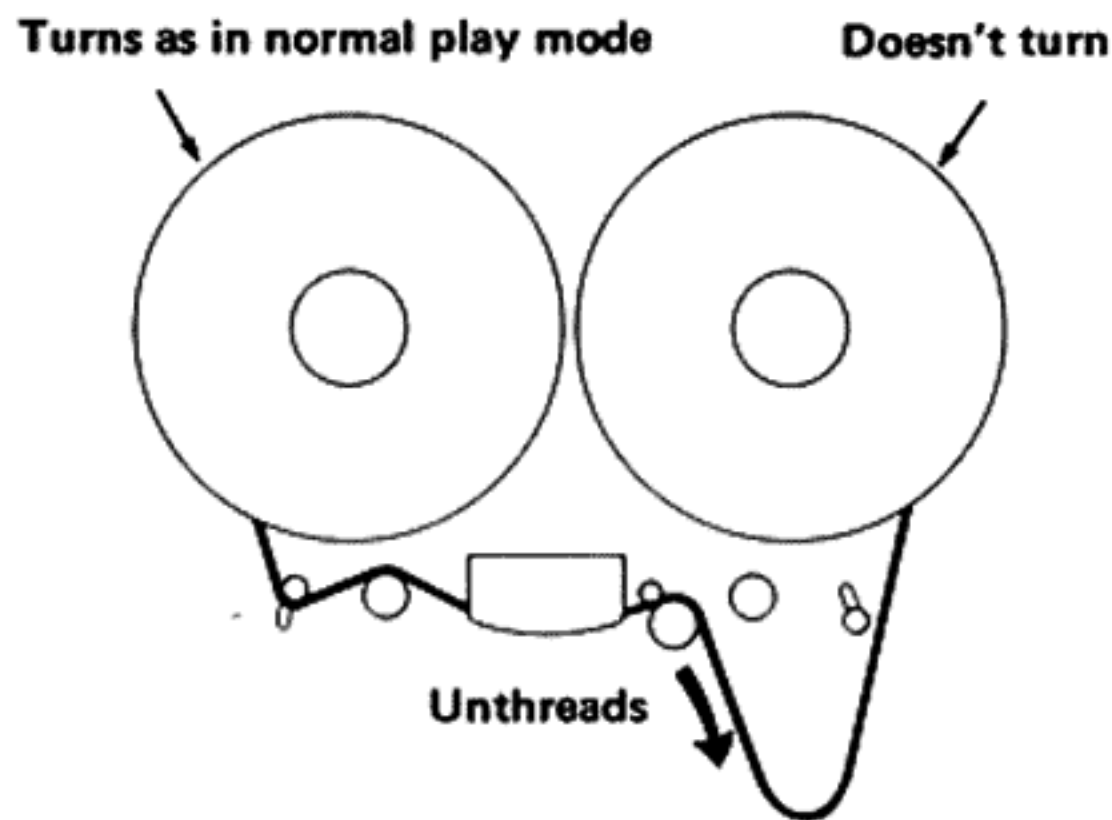

NOTE: Dump Edit can not be enabled unless EDIT and PLAY are pressed simultaneously. Pressing EDIT then PLAY only causes the tape to play normally. Pressing EDIT after PLAY has no effect; the tape continues to play.

4) Spot Erase

This function makes it easy to erase specific portions on a given track. First, designate the track to be erased by pressing on its Record Enable button. Press INSERT so you can hear tape, enter the Manual Edit mode as explained above and "hand rock" the reels until you cue out the spot to be erased. Then back up the tape slightly so that the portion you were hearing is now at the erase head (a china marker on the tape point is helpful for this). Press and hold RECORD while slowly moving the tape by hand. Erasure continues for as long as you advance the tape with RECORD hold down.

How the dbx Works

The DBX is a wide-band compression-expansion system which provides a net noise reduction (broad-band, not just hiss) of a little more than 30 dB. In addition, the compression during recording permits a net gain in tape headroom of about 10 dB.

A compression factor of 2:1 is used before recording; then, 1:2 expansion on reproduce. These compression and expansion factors are linear in decibels and allow the system to produce tape recordings with over a 100 dB dynamic range — an important feature, especially when you're making live recordings. The DBX employs RMS level sensors to eliminate compressor-expander tracking errors due to phase shifts in the tape recorder, and provides excellent transient tracking capabilities.

To achieve a large reduction in audible tape hiss, without danger of overload or high-frequency self-erasure on the tape, frequency pre-emphasis and de-emphasis are added to the signal and RMS level sensors.

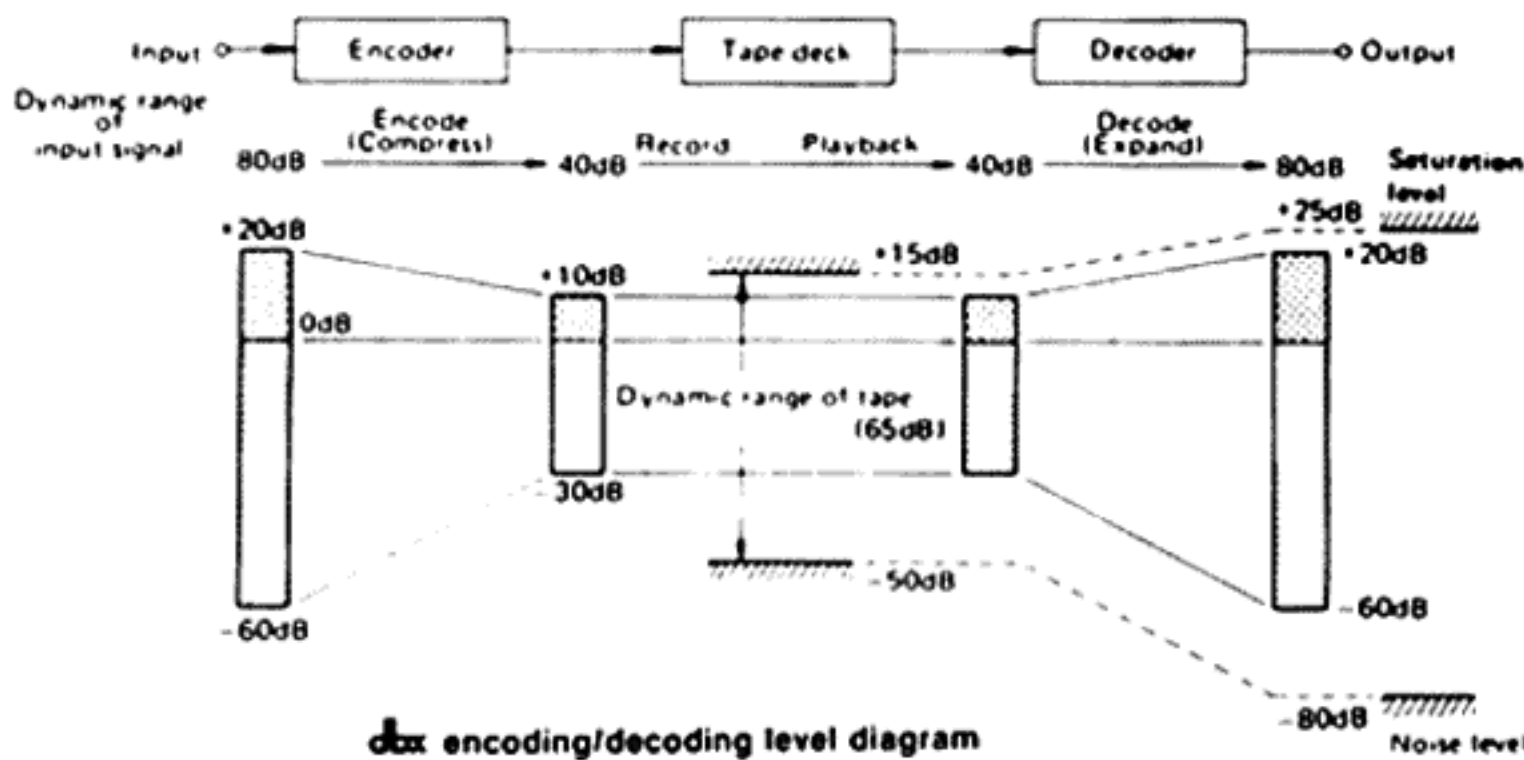

dbx encoding/decoding level diagram

SUBSONICS AND INTERFERENCE

The DBX incorporates an effective bandpass filter. This filter suppresses undesirable subsonic frequencies to keep them from introducing errors into the encode or decode process. However, if rumble from trains or trucks is picked up by your microphone and fed to the DBX, modulation of the program material during low level passages may occur. This low-frequency component will not itself be passed through the recorder and so, will not be present at reproduce for proper decoding. If this low-level decoding error is encountered, and subsonics are suspected, we suggest the addition of a suitable high-pass filter in the Microphone Line.

Care and Maintenance

We can't stress the importance of cleaning and demagnetizing too much. Oxide shed from the tape and accumulated on the heads and other components in the tape path and dust or debris picked up from the air can result in poor high frequency response. Also, the heads may become magnetized. This residual magnetism can increase noise and distortion, significantly degrading record/reproduce performance. Clean up and demagnetize at least every day before you start to work with the TSR-8.

CLEANING

1. Press down the head shield to get full access to the heads.

2. Apply cleaner to a cotton swab or lint-free gauze and wipe the entire surface of the tape path. Wipe off any excess cleaning fluid with a dry swab.

CAUTION: Be sure to use a good cleaner. We recommend the following:

TEAC HC-1 (U.S. only) or TZ-261A (for heads, tape guides, guide roller, and capstan shaft); and

TEAC RC-1 (U.S. only) or TZ-261B (for pinch roller and counter roller).

DEGAUSSING (DEMAGNETIZING)

A little stray magnetism can become quite a big nuisance in tape recording. It only takes a small amount (.2 Gauss) to cause trouble on the record head. (Gauss is the unit used to measure magnetism.) A little more than that (.7 Gauss) will start to erase high frequency signals on previously recorded tapes. You can see that it's worth taking the trouble to degauss regularly.

DEGAUSSING IS ALWAYS DONE WITH THE RECORDER TURNED OFF. If you try it with the electronics on, the current pulses produced by the degausser will look just like audio signals to the heads. These pulses are around 10,000 Gauss, and will seriously damage the electronics and/or meters. Turn off your TSR-8, then turn on the degausser at least 1 m (3 feet) away from the recorder.

Be certain that your degausser has either a plastic cover or plastic tape covering the tip. Make sure that no metal ever touches the tape heads as it will scar them and ruin them.

Slowly move in to the tape path. Move the degausser slowly back and forth, touching lightly all metal parts in the tape path. Slowly move it away again to at least 1 m (3 feet) from the recorder before turning it off.

Be sure to concentrate while you are degaussing. Don't try to hold a conversation or think of anything else but the job you are doing. If the degausser is turned on or off by accident while it is near the heads, you may put a permanent magnetic charge on them that no amount of careful degaussing will remove. You will have to get the heads replaced. Make sure you are wide awake for this job.

A clean and properly demagnetized tape recorder will maintain its performance without any other attention for quite a while. It won't ruin previously recorded material, nor will getting it back to original specifications be difficult.